



**Now
Available
COLOR LUX®
ASPEN
DOUBLE
HONEYCOMB**



2020

MDS Midwest
WINDOW FASHIONS Designer
Supply

www.midwestdesignersupply.com

888-523-2611
262-524-1007 (fax)

COLOR LUX®

Roller Shades / Cellular Shades / Panel Track Shades
Sheer Shadings / Custom Graphics

 **Comfortex**
WINDOW FASHIONS

Manufacturer's Price List and Reference Guide
Effective February 1, 2020

Comfortex Color Lux[®] Cellular, Roller, Panel Track Shades and Shangri-La[®] Sheer Horizontal Shadings Price List and Reference Guide | Effective February 1, 2020

This price list and reference guide contains product pricing, product specifications and technical information for the complete line of Comfortex Color Lux Cellular, Roller, Panel Track and Sheer Shadings.

Color Lux Cellular Shades	Page
Hardware Options	1-2
Size Standards	3-5
Shade Stack Heights	6
Pricing Examples	6
Hardware Upgrades and Surcharges	7

Color Lux Cellular Shades Pricing

Standard Rectangular - Color Lux Linen Weave, Aspen, Verona Textures & Boutique Light Filtering	Price Group 1 8
Standard Rectangular - Color Lux Linen Weave, Verona Textures & Boutique Room Darkening	Price Group 2 9
Ovation™ Cellular Sliders - Color Lux Linen Weave, Aspen, Verona Textures & Boutique Light Filtering and Color Lux Linen Weave, Verona Textures & Boutique Room Darkening	Price Group 3 & 4 10
Starburst Non-Movable & Movable Arches - Non-Movable & Movable Quarter Rounds - Color Lux Linen Weave, Aspen, Verona Textures & Boutique Light Filtering and Color Lux Linen Weave, Verona Textures & Boutique Room Darkening.	Price Group 5 & 6 11
Sunset™ Movable Arches - Color Lux Linen Weave, Aspen, Verona Textures & Boutique Light Filtering and Color Lux Linen Weave, Verona Textures & Boutique Room Darkening.	Price Group 7 & 8 12
Trapezoids and Octagons - Color Lux Linen Weave, Aspen, Verona Textures & Boutique light Filtering and Color Lux Linen Weave, Verona Textures & Boutique Room Darkening.	Price Group 9 & 10 13
Mezzo Motorized Skylights - Color Lux Linen Weave, Aspen, Verona Textures & Boutique Light Filtering and Color Lux Linen Weave, Verona Textures & Boutique Room Darkening.	Price Group 11 & 12 14
Soprano Skylights - Color Lux Linen Weave, Verona Textures & Boutique Light Filtering and Color Lux Linen Weave, Verona Textures & Boutique Room Darkening	Price Group 13 & 14 15
Non-Movable French Door Decor - Color Lux Linen Weave, Verona Textures & Boutique Light Filtering and Color Lux Linen Weave, Verona Textures & Boutique Room Darkening	Price Group 15 & 16 16
Movable French Door Decor - Color Lux Linen Weave, Verona Textures & Boutique Light Filtering and Color Lux Linen Weave, Verona Textures & Boutique Room Darkening	Price Group 17 & 18 17

Color Lux Cellular Shades Hardware

Standard Cord Lock Shades	18-19
Cord Loop Hardware System	20-21
Cordless Ultra™ Hardware System	22-23
Cordless Lift & Lock Hardware System	24-25
Motorized Shades (including Rechargeable Battery Motorization)	26-32

	Page
7.4V Rechargeable Motorized Top Down-Bottom Up Shades	31-32
7.4V EZ Charge Extension Wand	33
12V Low Voltage Hardwiring	34
Simplicity Smart Controller	35
7.4V Rechargeable PowerTouch Motorized Shades	36-37
Ovation Cellular Sliders	38-39
7.4V Rechargeable Simplicity Wave Motorized Shades	40-41
Insulating SlumberShades	42-43
StrataView Shades	44-45
Starburst Arches	46
Quarter Rounds	47-48
Sunset Arches	49-50
Trapezoids and Octagons	51-52
Mezzo Motorized Skylight Shades	53-55
Soprano Skylights	56-57
French Door Decor	58-59
Day-Night Shades	60-61
Highlights Cornice Valance	62

Color Lux Roller Shades

Key Features for Roller Hardware Options	65-66
Skyline Hardware Roller Shades	67-68
Color Lux Fabric Information and Fire Rating	69

Color Lux Roller Shades Pricing

Color Lux Classic Duck Light Filtering	Price Group 19	70
Color Lux Classic Duck Blackout	Price Group 20	71
Color Lux Linen Light Filtering	Price Group 21	72
Color Lux Linen Blackout	Price Group 22	73
Color Lux Solar Screen 5	Price Group 23	74

Color Lux Roller Shades Hardware

Skyline Standard Roller	75
Skyline Hardware Tensioner Information	76
Cord Loop Information	76
Cordless Roller with Deco-Bar Hardware	77
Cordless Options	78
Tassels and Pulls	79
General Information	80
FeatherTouch Cordless	81-82
Designer Cassette with Insert Strip	83
Designer Cassette with Fabric Wrap	83
Designer Cassette with Smooth Face	83
Two-on-One Head Rail	84
Dual Roller with Skyline Cord Loop & Motorization Hardware	85
Designer Cassette with Retractable Cord	87
Designer Cassette with Simplicity Rechargeable Wave	89
Four Inch Skyline Fascia	91

	Page
Designer Cassette & No Head Rail with PowerTouch Rechargeable	93
Simplicity Rechargeable Motorization	95
7.4 EZ Charge Extension Wand	97
12V Low Voltage Hardwiring	98
Simplicity 5 Channel Remote Information	99
Simplicity 6 Channel Timer Remote Information	99
Simplicity 14 Channel Remote Information	99
Highlights Cornice Valance with Keystone	101

Color Lux Panel Track System Shades

Features and Benefits of the Panel Track System	105
Stacking Options	105
Panel Attachment Method	105
Head Rail Colors	105
Bottom Rail Style	105
Fabric Panel Information	105
Panel Custom Overlaps	105
Control Options	106
Panel Widths	106
Head Rail Splicing	106
Track Specifications	106

Color Lux Panel Track System Shades Pricing

Includes Classic Duck Light Filtering, Classic Duck Blackout, Linen Light Filtering, Linen Blackout, and Solar Screen 5	Grid 24 & 25 107
--	---------------------------------------

Color Lux Panel Track System Shades Specifications

Finished Dimensions	108
Mounting Options	108
Panel Stack Back	108
Light Gap	108
Fabric Deductions and Specifications	108
Highlights Valance	108
Clear Window Opening and Stack Panels	109
Outside Mount Hardware Profiles	110
Inside Mount Hardware Profiles	111

Color Lux Custom Graphics

General Information and How to Order	113-115
--	---------

Color Lux Custom Graphics Pricing

Classic Duck Light Filtering	Price Group 26 116
Classic Duck Blackout	Price Group 27 116
E Screen 5%	Price Group 28 117

Color Lux Shangri-La Sheer Horizontal Shadings

Features At A Glance	118
Key Features	119-120

	Page
Fabric Collections and Vane Sizes	121
Fabric Collection Size Standards	122-124
Hardware Upgrades and Surcharges	125

Color Lux Shangri-La Sheer Horizontal Shadings Pricing

3" Light Filtering	Price Group 29	126
3" Room Darkening	Price Group 30	126
3" DoorStyles Light Filtering	Price Group 31	127
3" DoorStyles Room Darkening	Price Group 32	127

Color Lux Shangri-La Sheer Horizontal Shadings Hardware

Cord Loop Designer Cassette Head Rail:	128-129
Cord Information for Color Lux Shangri-La Sheer Horizontal Shadings.	129
Reverse Roll	129
Length Considerations with Color Lux Shangri-La Sheer Horizontal Shadings	129
Side by Side Alignment	129
Omni-View System	129
Retractable Cord	130
Two-On-One	131
Cordless	132-133
DoorStyles	134-135
7.4V PowerTouch Rechargeable Motorization	136-137
12V Non-Rechargeable Simplicity Motorization	138-139
7.4V Rechargeable Simplicity Motorization	140-142
Solar Panel Recharge Option	142
7.4V EZ Charge Extension Wand.	143
Simplicity Smart Controller	145
Certified Fabrics	146
Flame Resistance	146
UV Protection	146
Vane Opening and Visibility	146
Vane Closure	146
Leveling Color Lux Shangri-La Sheer Horizontal Shadings	146
Measuring Instructions for Color Lux Shangri-La Sheer Horizontal Shadings	147
Skew Adjusting Bottom Rail	147
Cleaning and Care	147

Color Lux General Information

Cut-Outs, Scotchgard™ Protection and Certified Fabrics	149
Highlights Cornice Valances	149
Stack Heights	149
Child Safety	150
Cleaning and Care	151
Measuring Instructions	151
Making Template	151
Conditions of Sale	152
Policies	152
Scotchgard™ Warranty	153
Color Lux Warranty Information	153-154
Motorized Color Lux Shades/Shadings Warranty	155

COLOR LUX® CELLULAR SHADES



COLOR LUX™
Designer Cellular & Roller Shades









Scotchgard™ Protection

Optional Scotchgard™ Protector is available with Color Lux Linen Shades. Scotchgard™ keeps your shades looking newer, fresher and cleaner longer.

A combination of the latest advances in stain release and repellency provides exceptional stain protection. Spills wipe away easily and most dirt and stains lift out when cleaned.







Color Lux® Cellular Shades
HARDWARE OPTIONS

COLORLUX® CELLULAR SHADES

	Key Features	Hardware Options	Hardware Size (Depth x Height)	Shade Size Available*	More Information
Standard Cord Lock 	<ul style="list-style-type: none"> • Proven cord lock • Sleek, fabric wrapped rails • UV resistant cords 	<ul style="list-style-type: none"> • Fabric Wrapped • Brushed Nickel • Oil Rubbed Bronze 	2¾" x ½"	Width: 8" to 108" Length: 8" to 120"	Page 18
Cord Loop 	<ul style="list-style-type: none"> • Cord Loop makes operation easy • Smooth & quiet operation 	<ul style="list-style-type: none"> • Fabric Wrapped • Brushed Nickel • Oil Rubbed Bronze 	2¼" x 1½"	Width: 14" to 108" Length: 8" to 120"	Page 20
Cordless Ultra 	<ul style="list-style-type: none"> • Child safe • No visible cords • Smooth & quiet operation 	<ul style="list-style-type: none"> • Fabric Wrapped • Brushed Nickel • Oil Rubbed Bronze 	2¼" x 1½"	Width: 15" to 108" Length: 8" to 84"	Page 22
Cordless Lift & Lock 	<ul style="list-style-type: none"> • Child safe • Easy push button operation • Rails lock securely in place in any position 	<ul style="list-style-type: none"> • Fabric Wrapped • Oil Rubbed Bronze 	2¾" x ½" Bottom Rail: 1⅞" x 1⅞"	Width: 16" to 96" Length: 8" to 84"	Page 24
12V Non-Rechargeable Simplicity Motorization 	<ul style="list-style-type: none"> • Raise & lower shade with click of a button • Great for large and hard to reach windows • Remote can operate multiple shades 	<ul style="list-style-type: none"> • Fabric Wrapped • Oil Rubbed Bronze 	2¼" x 1½"	Width: 18" to 96" Length: 8" to 120"	Page 26
7.4V Rechargeable Simplicity Motorization 	<ul style="list-style-type: none"> • Features a battery powered motor utilizing a rechargeable battery pack • Raise & lower shade with click of a button • Great for large and hard to reach windows • Remote can operate multiple shades 	<ul style="list-style-type: none"> • Fabric Wrapped • Oil Rubbed Bronze 	2¼" x 1½"	Width: 18" to 96" Length: 8" to 120"	Page 28
7.4V Rechargeable PowerTouch 	<ul style="list-style-type: none"> • Raise & lower shade with push of a button • Eliminate the need to stand by the shade to operate; just touch and go • Favorite position button • Rechargeable battery pack with recharge port on pendant 	<ul style="list-style-type: none"> • Wand and pendant available in white or black 	2¼" x 1½"	Width: 18" to 96" Length: 8" to 120"	Page 36

* Maximum widths and lengths listed do not take into account square foot or weight limitations. Make sure to refer to shaded areas on price groups for maximum size availability by fabric style.

Color Lux® Cellular Shades
HARDWARE OPTIONS

	Key Features	Color Options	Hardware Size (Depth x Height)	Shade Size Available*	More Information
<p>Simplicity Wave Rechargeable Motorization</p> 	<ul style="list-style-type: none"> • Features a battery powered motor utilizing a rechargeable battery • Raise & lower shade with the wave of a wand • Great for out of reach windows • Exact match soft fabric wrapped rails 	<ul style="list-style-type: none"> • Fabric Wrapped 	2¼" x 1½"	<p>Width: 17½" to 96"</p> <p>Length: 12" to 120"</p>	Page 40
<p>Ovation™ Slider</p> 	<ul style="list-style-type: none"> • Vertically oriented fabric glides across window • Shade can stack left, right or center • Great for sliding glass doors or room dividers 	<ul style="list-style-type: none"> • White (Standard) • Ivory • Beige • Tan • Gray 	3⅝" x 1¾"	<p>Width: 12" to 168"</p> <p>Length: 24" to 108"</p>	Page 38
<p>Door Décor</p> 	<ul style="list-style-type: none"> • Great option for narrow windows and doors • Available in movable & non-movable rails • No Pull cords 	<ul style="list-style-type: none"> • Fabric Wrapped • Brushed Nickel • Oil Rubbed Bronze 	2⅜" x ½"	<p>Width: 3" to 36"</p> <p>Length: 12" to 96"</p>	Page 58
<p>Top Down-Bottom Up</p> 	<ul style="list-style-type: none"> • Lower shade from top: raise from bottom • Great for privacy • Ideal for light control • NEW! Motorization Available 	<ul style="list-style-type: none"> • Fabric Wrapped • Oil Rubbed Bronze 	2⅜" x ½"	<p>Width: 18" to 108"</p> <p>Length: 8" to 120"</p>	See Product Availability Page 17-24
<p>Two on One Head Rail</p> 	<ul style="list-style-type: none"> • Operate two shades on one rail • Great for larger windows • Individually operating shades 	<ul style="list-style-type: none"> • Fabric Wrapped • Oil Rubbed Bronze 	Dependent on Hardware Chosen See Above	<p>Width: 16" to 144"</p> <p>Length: 8" to 120"</p>	See Product Availability Page 18-29
<p>Highlights Cornice Valance</p> 	<ul style="list-style-type: none"> • Adds height to windows and hides hardware • Available as inside and outside mount • Easy to install 	<ul style="list-style-type: none"> • All Color Lux Roller Fabrics • All Envision Roller Fabrics 	<p>Width: 24" to 216"</p> <p>Height: 6"</p> <p>Returns: 1½" to 6"</p>	<p>Varies by selected fabric</p> <p>Width: 12" to 94"</p>	Page 62
<p>Insulating SlumberShade™</p> 	<ul style="list-style-type: none"> • Ultimate blackout shade • Tracks keep out light, cold or heat • Perfect for nurseries, day sleepers • Available in Cord Lock, Cord Loop, Cordless and motorized • Note: Not available on Boutique fabrics 	<ul style="list-style-type: none"> • Fabric Wrapped • Brushed Nickel • Oil Rubbed Bronze • Sidetracks are available in white, tan or bronze 	Dependant on hardware choice	<p>Width: 9" to 96"</p> <p>Length: 8" to 120"</p>	Page 42

* Maximum widths and lengths listed do not take into account square foot or weight limitations. Make sure to refer to shaded areas on price groups for maximum size availability by fabric style.

Color Lux® Cellular Shades
SIZE STANDARDS

COLORLUX® CELLULAR SHADES



				Cord Lock		Cord Loop		Cordless Ultra		Cordless Lift & Lock	
Minimum				Standard	TD-BU	Standard	TD-BU	Standard	TD-BU	Standard	TD-BU
COLOR LUX® FABRICS				Min. Width	8" 12"	14" 22"	15" OB 18" OB 15 3/8" IB 18 3/8" IB	16" OB 20" OB 16 3/8" IB 20 3/8" IB	8" 8"	8" 8"	8" 8"
				Min. Length	8" 8"	8" 8"	8" 8"	8" 8"	8" 8"	8" 8"	
				Cord Lock		Cord Loop		Cordless Ultra		Cordless Lift & Lock	
Linen Weave, Aspen LF, Verona Textures & Boutique				Standard	TD-BU	Standard	TD-BU	Standard	TD-BU	Standard	TD-BU
Price Group	Page		Maximum Width & Length	108" width 120" length	96" width 96" length	108" width 120" length	108" width 120" length	108" width 84" length	96" width 84" length	96" width 84" length	96" width 84" length
Light Filtering	1	8		108" width 120" length	84" width 96" length	108" width 120" length	108" width 120" length	108" width 84" length	96" width 84" length	96" width 84" length	96" width 84" length
Room Darkening <i>Excluding Aspen</i>	2	9		108" width 120" length	84" width 96" length	108" width 120" length	108" width 120" length	108" width 84" length	96" width 84" length	96" width 84" length	96" width 84" length
				Cord Lock		Cord Loop		Cordless Ultra		Cordless Lift & Lock	
Stacking Heights Information On Page More Information On Page				Page 6 Page 18		Page 6 Page 20		Page 6 Page 22		Page 6 Page 24	

+ Maximum Width & Length and Minimum Width & Length applies to StrataView Shades



				Motorization		Motorization		Two-On-One Head Rail		Ovation
Minimum				Simplicity+	Simplicity Wave	PowerTouch Rechargeable	Cord Lock*	Cord Loop/Cordless**	Standard	
COLOR LUX® FABRICS				Minimum Width	18" OB 18 3/8" IB	17 3/8"	18" OB 18 3/8" IB	16" 36"	12"	
				Min. Length	8" 12"	8"	8" 8"	24"		
				Motorization		Motorization		Two-On-One Head Rail		Ovation
Linen Weave, Aspen LF, Verona Textures & Boutique				Simplicity~	Simplicity Wave	PowerTouch Rechargeable	Cord Lock*	Cord Loop/Cordless**	Standard	
Light Filtering			Maximum Width & Length	108" width 120" length	96" width 120" length	108" width 120" length	144" width 120" length	144" width 120" length	120" width*** 108" length	
Room Darkening <i>Excluding Aspen</i>			Maximum Width & Length	108" width 120" length	96" width 120" length	108" width 120" length	144" width 120" length	144" width 120" length	120" width*** 108" length	
				Motorization		Motorization		Two-On-One Head Rail		Ovation
Stacking Heights Information On Page More Information On Page				Simplicity	Simplicity Wave	PowerTouch Rechargeable	Cord Lock	Cord Loop/Cordless	Standard	
				Page 6 Page 26-41		Page 6 Page 36		Page 6 Page 18-29		Page 6 Page 38

Motorized shades less than 24" in width are limited to a maximum of 60" in length. Cordloop and cordless shades less than 24" in width are limited to 84" in length.

Maximum widths and lengths listed do not take into account square foot or weight limitations. Make sure to refer to shaded areas on price groups for maximum size availability by fabric style. * Minimum single panel is 8", maximum single panel is 108". ** Minimum single panel is 18", maximum single panel is 108". *** Split stack sliders are available is 240", however if the width exceeds 120", the shade will be fabricated as two separate sliders. Supplied valance will create the appearance of a single slider. + Minimum for Motorized Top Down-Bottom Up is 24" IB and 23 3/8" OB. Minimum length and maximum length and width are the same as Simplicity motorization specs.

Color Lux® Cellular Shades
SIZE STANDARDS



		SlumberShade Cord Lock		SlumberShade Cord Loop		SlumberShade Cordless		Motorization
		Bottom Up	Top Down Bottom Up	Bottom Up	Top Down Bottom Up	Bottom Up	Top Down Bottom Up	7.4V Simplicity+ Rechargeable
Minimum								
LINEN WEAVE FABRICS (not available in Boutique fabrics)	Minimum Width	9"	13"	15"	25"	16 ³ / ₈ " IB	19 ³ / ₈ " IB	19 ³ / ₈ "
	Min. Length	8"	8"	8"	8"	8"	8"	8"

				SlumberShade Cord Lock		SlumberShade Cord Loop		SlumberShade Cordless		Motorization
				Bottom Up	Top Down Bottom Up	Bottom Up	Top Down Bottom Up	Bottom Up	Top Down Bottom Up	7.4V Simplicity+ Rechargeable
Light Filtering	Price Group	Page								
Linen Weave Verona Textures Aspen	1	8	Maximum Width & Length							
			Refer to shaded area in price grids for max size (sq ft) by fabric style	96" width 120" length	96" width 96" length	96" width 120" length	96" width 120" length	96" width 84" length	96" width 84" length	108" width 120" length

				SlumberShade Cord Lock		SlumberShade Cord Loop		SlumberShade Cordless		Motorization
				Bottom Up	Top Down Bottom Up	Bottom Up	Top Down Bottom Up	Bottom Up	Top Down Bottom Up	7.4V Simplicity+ Rechargeable
Room Darkening & Blackout	Price Group	Page								
Linen Weave Verona Textures	2	9	Maximum Width & Length							
			Refer to shaded area in price grids for max size (sq ft) by fabric style	96" width 120" length	84" width 96" length	96" width 120" length	96" width 120" length	96" width 84" length	96" width 84" length	108" width 120" length

				SlumberShade Cord Lock		SlumberShade Cord Loop		SlumberShade Cordless		Motorization
				Bottom Up	Top Down Bottom Up	Bottom Up	Top Down Bottom Up	Bottom Up	Top Down Bottom Up	7.4V Simplicity+ Rechargeable
Stacking Heights Information On Page More Information On Page				Page 6 Page 42-43		Page 6 Page 42-43		Page 6 Page 42-43		Page 6 Page 42-43

Please Note: For any shades under 12" width, the maximum height is 80".

Color Lux® Cellular Shades

SIZE STANDARDS

COLORLUX® CELLULAR SHADES

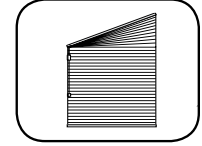
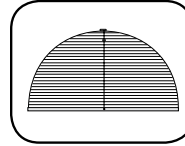
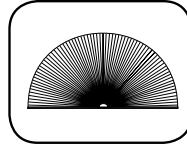

		Starburst Arch	Sunset Arch	Mezzo Skylight	Trapezoid
Minimum		Non-Movable/Movable	Movable	Motorized	Standard
COLOR LUX® FABRICS	Min. Width	18"	18"	18"	12"
	Min. Length	9"	6"	12"	12"
		Starburst Arch	Sunset Arch	Mezzo Skylight	Trapezoid
Linen Weave, Aspen LF, Verona Textures & Boutique		Non-Movable/Movable	Movable	Motorized	Standard
Light Filtering	Maximum Width & Length	72" x 36"	72" x 60"	48" x 72"	48" x 72"
Room Darkening	Maximum Width & Length	72" x 36"	60" x 60"	48" x 72"	48" x 72"
		Starburst Arch	Sunset Arch	Mezzo Skylight	Trapezoid
		Non-Movable/Movable	Movable	Motorized	Standard
Stacking Heights Information On Page More Information On Page		Page 6 Page 46	Page 6 Page 49	Page 6 Page 53	Page 6 Page 51

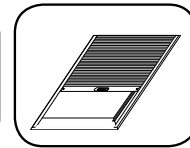
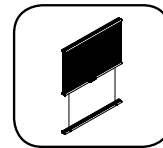
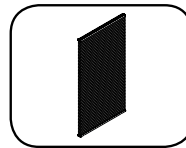
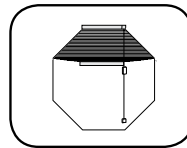

		Octagon	French Door Décor		Soprano Skylights
Minimum		Standard	Non-Movable	Movable	Movable
COLOR LUX® FABRICS	Minimum Width	12"	6"	6"	6"
	Min. Length	12"	12"	12"	12"
		Octagon	French Door Décor		Soprano Skylights
Linen Weave, Aspen LF, Verona Textures & Boutique		Standard	Non-Movable	Movable	Movable
Light Filtering	Maximum Width & Length	48" width 48" length	36" width 96" length	36" width 96" length	48" width 72" length
Room Darkening	Maximum Width & Length	48" width 48" length	36" width 96" length	36" width 96" length	48" width 72" length
		Octagon	French Door Décor		Soprano Skylights
		Standard	Non-Movable	Movable	Movable
Stacking Heights Information On Page More Information On Page		Page 6 Page 51	Page 6 Page 58	Page 6 Page 58	Page 6 Page 56

Color Lux® Cellular Shades

SHADE STACK HEIGHTS

Measurements are in inches. Shade stacking heights applicable when the shade is in the fully raised position.

COLORLUX® CELLULAR SHADES

RECTANGULAR CORD LOCK - Includes head and bottom rails	48"	72"	84"	96"
Linen Weave, Aspen*, Verona Textures & Boutique Light Filtering and Room Darkening Fabrics	2"	2 ³ / ₈ "	2 ⁵ / ₈ "	2 ⁷ / ₈ "

For Top Down-Bottom Up, add ³/₈" | *Aspen available in light filtering only

CORD LOOP - CORDLESS ULTRA - MOTORIZATION - Includes head and bottom rails	48"	72"	84"	96"
Linen Weave, Aspen*, Verona Textures & Boutique Light Filtering and Room Darkening Fabrics	3"	3 ³ / ₈ "	3 ⁵ / ₈ "	3 ⁷ / ₈ "
StrataView™	4 ³ / ₈ "	5 ¹ / ₂ "	6"	6 ¹ / ₂ "

*Aspen available in light filtering only

CORDLESS LIFT & LOCK - Includes head and bottom rails	48"	60"	72"	84"
Linen Weave, Aspen*, Verona Textures & Boutique Light Filtering and Room Darkening Fabrics	2 ³ / ₄ "	3 ¹ / ₈ "	3 ³ / ₈ "	3 ⁵ / ₈ "

For Top Down-Bottom Up, add 1¹/₄" | *Aspen available in light filtering only

OVATION	84"	96"	108"	120"
Linen Weave, Aspen, Verona Textures & Boutique Light Filtering and Room Darkening Fabrics	6 ¹ / ₂ "	7 ¹ / ₄ "	8"	8 ³ / ₄ "

Ovations minimum fabric stack measures 6¹/₂" regardless of the ordered width. Fabric stacking dimensions are determined by the slider's hardware, not ordered width.

*Aspen available in light filtering only

Color Lux Cellular Shade Pricing Examples

Rechargeable Simplicity Pricing Example:

Linen Weave	
Light Filtering 42" x 60" Shade:	\$422.00
Simplicity Rechargeable Motor Surcharge:	\$368.00
Charger for Rechargeable:	\$30.00
Simplicity 5 Channel Remote Control:	\$44.00
Total List Price:	\$864.00

Motorized Top Down-Bottom Up Pricing Example:

Linen Weave	
Light Filtering 42" x 60" Shade:	\$422.00
Simplicity Rechargeable TDBU Surcharge:	\$589.00
Charger for Rechargeable:	\$30.00
TDBU Remote Control:	\$72.00
Total List Price:	\$1113.00

PowerTouch Rechargeable Pricing Example:

Linen Weave	
Light Filtering 42" x 60" Shade:	\$422.00
PowerTouch Rechargeable Surcharge:	\$132.00
Charger for Rechargeable:	\$30.00
Total List Price:	\$584.00

StrataView Motorization Pricing Example:

Linen Weave	
Light Filtering 42" x 60" Shade:	\$422.00
Simplicity Rechargeable Surcharge:	\$786.00
Charger for Rechargeable:	\$30.00
TDBU Remote Control:	\$72.00
Total List Price:	\$1310.00

Color Lux® Cellular Shades

HARDWARE UPGRADE OPTIONS

COLORLUX® CELLULAR SHADES

LIFT SYSTEM	UPGRADES	ADD	DESIGNER UPGRADE OPTIONS	UPGRADES	ADD
Cord Lock	Top Down-Bottom Up	\$68	Add to Any Lift System Upgrade (Chart to the left)	Metallic Hardware	No Extra Charge
	Cordless Lift & Lock Surcharge	Bottom Up		Fabric Wrapped Hardware	No Extra Charge
	Top Down-Bottom Up	\$88		Scotchgard Stain Protection	\$38
Cordless Ultra	Bottom Up	\$88		Highlights Valance See Page 62 For More Information	
	Top Down-Bottom Up	\$176	SlumberShades Light Blocking Sidetrack System	Insulating SlumberShades See Page 42 For More Information	\$142
Cord Loop	Bottom Up	\$88			
	Top Down-Bottom Up	\$176			
ADDITIONAL OPTIONS	UPGRADES	ADD			
Add to Any Upgrade Above	Two-On-One Head Rail	\$52 Add to Cord Lock, Cordless or Cord Loop Head Rail			
	Cut Outs	\$55 Per side			
	Day-Night	Price each panel as separate shade and add together			
	StrataView™	\$362 (includes Top Down-Bottom Up & top sheer fabric additions) Available on Cordless Ultra, Cord Loop and motorized. (Not available with Aspen)			
	Ovation Center Stack	\$88			
Accessories	6 Foot Expandable Pole	\$44			
	12 Foot Expandable Pole	\$54			

Cellular Shade Motorized Hardware Upgrade Options

MOTORIZED	UPGRADES	ADD	
7.4 V PowerTouch Rechargeable Motorization System	Rechargeable Integrated Battery Pack	\$132	For More Information Page 36
	Plug-In Charger for Rechargeable Li-Ion	\$30	
12V Simplicity Motorization System (non-rechargeable)	Motor and Battery Wand	\$368	For More Information Page 26
	48" Extension Wire	\$20	
	Single Unit DC Power Supply/Transformer	\$80	
7.4V Simplicity Rechargeable Motorization System	Motor and Integrated Battery Pack	\$368	For More Information Page 28
	Plug-In Charger for Rechargeable Li-Ion	\$30	
	7.4v Solar Panel & Mounting Brackets	\$110	
Simplicity Systems Controllers	NEO Controller	\$363	For More Information Pages 26-35
	NEO Application for Mobile Devices	FREE	
	Simplicity 5 Channel Remote	\$44	
	Simplicity 6 Channel Remote with Timer	\$72	
	Simplicity 14 Channel White Remote	\$72	
	StrataView™*	\$786	
	Top Down-Bottom Up**	\$589	
Top Down-Bottom Up/StrataView 14 Channel Remote***	\$72		
7.4V EZ Charge Extension Wand	Wall Mount Receiver Kit	\$20	For More Information Page 33
	Extendable Wand	\$37	
12V Low Voltage Hardwiring	9 Channel Wall Mount Transformer	\$285	For More Information Page 34

*Upcharge includes Top Down-Bottom Up surcharge & top sheer fabric addition \$197

**Upcharge includes motorization surcharge of \$334, plus \$201 for second motor and Top Down-Bottom Up components

*** TDBU Remote required for Motorized Top Down-Bottom Up and StrataView shades

Color Lux® Cellular Shades
PRICING

Color Lux® Linen Weave, Aspen, Verona Textures & Boutique Light Filtering
Price Group 1
Cord Lock - Fabric Wrapped or Designer Metallic Rails
Cordless Lift & Lock - Fabric Wrapped or Designer Metallic Rail

		Width In Inches														
		24	30	36	42	48	54	60	66	72	84	96	108	120	132	144
Length In Inches	36	231	254	288	320	349	379	409	435	466	532	595	658	726	788	852
	42	245	278	308	345	379	412	447	478	512	585	655	727	805	883	962
	48	257	296	334	370	409	446	481	521	558	649	738	827	917	1006	1095
	54	275	312	354	394	437	477	527	576	627	727	827	928	1027	1128	1229
	60	291	333	379	422	465	527	582	637	693	805	916	1027	1140	1251	1362
	66	303	349	401	455	515	576	637	699	760	883	1006	1128	1251	1373	1496
	72	320	366	422	493	560	627	693	760	827	962	1095	1229	1362	1496	1629
	78	334	388	459	532	604	677	750	822	894	1039	1184	1328	1473	1619	1763
	84	343	415	493	572	649	727	805	883	962	1116	1273	1429	1585	1740	1896
	90	358	443	527	610	693	778	861	944	1027	1195	1362	1528	1696	1863	2030
96	382	471	560	649	738	827	916	1006	1095	1273	1451	1629	1807	1985	2163	
108	426	527	627	727	827	928	1027	1128	1229	1429	1629	1829	2030	2230	2431	
120	471	582	693	805	916	1027	1140	1249	1362	1585	1806	2030	2252	2476	2698	

Motorized Lift Systems are not offered within the shaded area.

Widths over 108" must be built as Two-On-One Shades. Surcharge is included in shades over 108" wide

LIFT SYSTEM	UPGRADES	ADD
Cord Lock	Top Down-Bottom Up	\$68
Cordless Lift & Lock Surcharge	Bottom Up	No Extra Charge
	Top Down-Bottom Up	\$88
Cordless Ultra	Bottom Up	\$88
	Top Down-Bottom Up	\$176
Cord Loop	Bottom Up	\$88
	Top Down-Bottom Up	\$176

DESIGNER UPGRADE OPTIONS	UPGRADES	ADD
Add to Any Lift System Upgrade (Chart to the left)	Metallic Hardware	No Extra Charge
	Fabric Wrapped Hardware	No Extra Charge
	Scotchgard Stain Protection	\$38
	Highlights Valance See Page 62 For More Information	

ADDITIONAL OPTIONS	UPGRADES	ADD
Add to Any Upgrade Above	Two-On-One Head Rail	\$52 Add to Cord Lock, Cord Loop, or Cordless Head Rail under 108" widths
	Cut Outs	\$55 Per side
	Day-Night	Price each panel as separate shade and add together
	StrataView™	\$362 (includes Top Down-Bottom Up & top sheer fabric additions)
Accessories	6 Foot Expandable Pole	\$44
	12 Foot Expandable Pole	\$54

MOTORIZATION	MORE INFO
Motorized Pricing Examples - Surcharges - Options	Pg 6-7
Insulating SlumberShades	\$142 See Page 42 For More Information. Not available with StrataView.

Color Lux® Cellular Shades
PRICING

COLORLUX® CELLULAR SHADES

Color Lux® Linen Weave, Verona Textures & Boutique Room Darkening

Price Group 2

Cord Lock - Fabric Wrapped or Designer Metallic Rails
Cordless Lift & Lock - Fabric Wrapped or Designer Metallic Rail

		Width In Inches														
		24	30	36	42	48	54	60	66	72	84	96	108	120	132	144
Length In Inches	36	301	331	375	416	454	493	532	566	606	692	774	856	994	1075	1158
	42	319	362	401	449	493	536	582	622	666	761	852	946	1097	1198	1301
	48	335	385	435	481	532	580	626	678	726	844	960	1076	1243	1358	1474
	54	358	406	461	513	569	621	686	749	816	946	1076	1207	1386	1517	1648
	60	379	433	493	549	605	686	757	829	901	1047	1191	1336	1532	1677	1821
	66	394	454	522	592	670	749	829	909	988	1148	1308	1467	1677	1835	1995
	72	416	476	549	641	728	816	901	988	1076	1251	1424	1598	1821	1995	2168
	78	435	505	597	692	786	881	975	1069	1163	1351	1540	1727	1965	2155	2342
	84	446	540	641	744	844	946	1047	1148	1251	1451	1655	1858	2111	2312	2515
	90	466	576	686	793	901	1012	1120	1228	1336	1554	1771	1987	2255	2472	2689
	96	497	613	728	844	960	1076	1191	1308	1424	1655	1887	2118	2400	2631	2862
108	554	686	816	946	1076	1207	1336	1467	1598	1858	2118	2378	2689	2949	3211	
120	613	757	901	1047	1191	1336	1482	1624	1771	2061	2348	2639	2978	3269	3558	

Motorized Lift Systems are not offered within the shaded area.

Widths over 108" must be built as Two-On-One Shades. Surcharge is included in shades over 108" wide

LIFT SYSTEM	UPGRADES	ADD
Cord Lock	Top Down-Bottom Up	\$68
Cordless Lift & Lock Surcharge	Bottom Up	No Extra Charge
	Top Down-Bottom Up	\$88
Cordless Ultra	Bottom Up	\$88
	Top Down-Bottom Up	\$176
Cord Loop	Bottom Up	\$88
	Top Down-Bottom Up	\$176

DESIGNER UPGRADE OPTIONS	UPGRADES	ADD
Add to Any Lift System Upgrade (Chart to the left)	Metallic Hardware	No Extra Charge
	Fabric Wrapped Hardware	No Extra Charge
	Scotchgard Stain Protection	\$38
	Highlights Valance See Page 62 For More Information	

ADDITIONAL OPTIONS	UPGRADES	ADD
Add to Any Upgrade Above	Two-On-One Head Rail	\$52 Add to Cord Lock, Cord Loop or Cordless Head Rail under 108" widths
	Cut Outs	\$55 Per side
	Day-Night	Price each panel as separate shade and add together
	StrataView™	\$362 (includes Top Down-Bottom Up & top sheer fabric additions)
Accessories	6 Foot Expandable Pole	\$44
	12 Foot Expandable Pole	\$54

MOTORIZATION	MORE INFO
Motorized Pricing Examples - Surcharges - Options	Pg 6-7
Insulating SlumberShades	\$142 See Pages 42 For More Information

Color Lux® Cellular Shades
PRICING

Color Lux® Linen Weave, Aspen, Verona Textures & Boutique Light Filtering

Price Group 3
Ovation Cellular Slider

Width In Inches

	24	30	36	42	48	54	60	66	72	78	84	96	108	120	132	144	156	168
36	505	547	596	640	677	723	769	809	854	902	941	1019	1096	1179	1259	1341	1425	1507
42	537	589	641	693	735	785	839	884	938	986	1029	1120	1205	1304	1400	1495	1591	1688
48	572	624	689	743	794	846	905	962	1017	1065	1121	1227	1319	1426	1532	1638	1742	1848
54	603	668	732	795	847	908	966	1034	1096	1153	1214	1327	1434	1549	1667	1782	1902	2017
60	638	706	775	843	905	971	1038	1108	1173	1238	1302	1427	1546	1672	1802	1929	2057	2188
66	674	747	822	895	962	1033	1102	1185	1252	1327	1386	1532	1658	1797	1930	2067	2203	2340
72	711	787	867	949	1025	1097	1172	1258	1334	1412	1480	1639	1770	1923	2076	2231	2384	2536
78	747	831	916	1003	1083	1162	1241	1336	1414	1496	1569	1736	1881	2044	2206	2368	2533	2694
84	785	872	961	1059	1143	1227	1312	1410	1496	1583	1661	1840	1995	2165	2340	2512	2682	2854
90	819	912	1012	1113	1198	1291	1384	1488	1579	1669	1757	1944	2105	2295	2485	2675	2866	3056
96	853	953	1060	1164	1257	1351	1458	1564	1661	1759	1847	2049	2221	2416	2611	2807	3005	3199
108	886	990	1105	1219	1313	1414	1527	1636	1741	1847	1939	2154	2335	2537	2737	2939	3139	3339

Color Lux® Linen Weave, Verona Textures & Boutique Room Darkening

Price Group 4
Ovation Cellular Slider

Width In Inches

	24	30	36	42	48	54	60	66	72	78	84	96	108	120	132	144	156	168
36	657	712	775	832	881	940	1000	1052	1111	1173	1224	1325	1425	1533	1637	1744	1853	1960
42	699	766	834	901	956	1021	1091	1150	1220	1282	1338	1456	1567	1696	1820	1944	2069	2195
48	744	812	896	966	1033	1100	1177	1251	1323	1385	1458	1596	1715	1854	1992	2130	2265	2403
54	784	869	952	1034	1102	1181	1256	1345	1425	1499	1579	1726	1865	2014	2168	2317	2473	2623
60	830	918	1008	1096	1177	1263	1350	1441	1525	1610	1693	1856	2010	2174	2343	2508	2675	2845
66	877	972	1069	1164	1251	1343	1433	1541	1628	1726	1802	1992	2156	2337	2509	2688	2864	3042
72	925	1024	1128	1234	1333	1427	1524	1636	1735	1836	1924	2131	2301	2500	2699	2901	3100	3297
78	972	1081	1191	1304	1408	1511	1614	1737	1839	1945	2040	2257	2446	2658	2868	3079	3293	3503
84	1021	1134	1250	1377	1486	1596	1706	1833	1945	2058	2160	2392	2594	2815	3042	3266	3487	3711
90	1065	1186	1316	1447	1558	1679	1800	1935	2053	2170	2285	2528	2737	2984	3231	3478	3726	3973
96	1109	1239	1378	1514	1635	1757	1896	2034	2160	2287	2402	2664	2888	3141	3395	3650	3907	4159
108	1152	1287	1437	1585	1707	1839	1986	2127	2264	2402	2521	2801	3036	3299	3559	3821	4081	4341

PRODUCT INFORMATION		
	See Page 38 for detailed information.	
DESIGN UPGRADES		
	Scotchgard Stain Protector	Add \$38 per shade
	Center Stack	Add \$88 Left or Right Stack Standard
	Split Stack*	Price by dividing the full width measurement in half. Price as two separate units and add together.
	Dual Panel**	Price as two separate units and add together.

* Split stack sliders are available in widths up to 240". If the width exceeds 120", it will be fabricated as two separate sliders. The supplied valance will create the appearance of a single slider.

** A Dual Panel Stack Slider has a center opening design with a different fabric on each side, each of which can span the full width of the window. Both panels will be of equal width unless otherwise specified.

Color Lux® Cellular Shades

PRICING

COLORLUX® CELLULAR SHADES

Color Lux® Linen Weave, Aspen, Verona Textures & Boutique Light Filtering

Price Group 5
Starburst Arches
Quarter Rounds

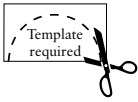

For widths wider than 58"

Fabric Wrapped or Designer Metallic Hardware Included

	Width In Inches								
	24	30	36	42	48	54	60	66	72
Non-Movable Starburst	296	333	375	424	503	573	643	723	811
Movable Starburst	408	459	520	584	694	775	869	969	1079
Non-Movable Quarter Rounds	375	424	480	544	615	696			
Movable Quarter Rounds	503	567	641	720	811				

Color Lux® Linen Weave, Verona Textures & Boutique Room Darkening

Price Group 6
Starburst Arches
Quarter Rounds

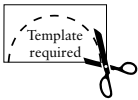

For widths wider than 58"

Fabric Wrapped or Designer Metallic Hardware Included

	Width In Inches								
	24	30	36	42	48	54	60	66	72
Non-Movable Starburst	409	457	512	576	678	769	860	964	1079
Movable Starburst	555	621	700	784	927	1032	1154	1284	1427
Non-Movable Quarter Rounds	512	576	648	732	824	929			
Movable Quarter Rounds	678	762	858	960	1079				

Non-Movable Starburst Product Information:

Templates required on non-perfect non-movable Starburst Arches. See page 46 for more information.
Fabric wrapped rail is standard. There will be a splice in the center. A decorative rosette is supplied to cover the splice.

Pricing Information:

Price according to the largest radius measurement. If the height is greater than the width, take height multiplied by 2 and use that number to determine pricing.

FABRIC SURCHARGES		ADD
Scotchgard Stain Protector		\$38
PRICING INFORMATION		
Starburst Arches	Price according to the largest radius measurement. If the height is greater than the width, take height X 2 and use that number to determine pricing. Metallic rails available.	
Quarter Rounds	Price according to the largest radius measurement.	
HARDWARE UPGRADE SURCHARGES* AND ACCESSORIES		ADD
Metallic Hardware or Fabric Wrapped Rails		No Extra Charge
6 Foot Expandable Pole		\$44
12 Foot Expandable Pole		\$54

Color Lux® Cellular Shades
PRICING

**Color Lux® Linen Weave, Aspen,
Verona Textures & Boutique Light Filtering
Fabric Wrapped or Designer Metallic Hardware Included**

**Price Group 7
Sunset Movable Arches**

	Width In Inches								
	24	30	36	42	48	54	60	66	72
Half Round	376	416	440	491	522	583	618	677	738
36	480	523	548	584	609	652	671	706	738
42	505	555	577	632	653	702	724	763	798
48	534	584	615	669	693	733	777	817	860
60	582	652	683	752	784	849	884	934	984

Sunset Product Information:

Templates required on non-perfect Sunset Arches. See page 47.

**Color Lux® Linen Weave, Verona Textures
& Boutique Room Darkening**

**Price Group 8
Sunset Movable Arches**
Fabric Wrapped or Designer Metallic Hardware Included

	Width In Inches						
	24	30	36	42	48	54	60
Half Round	482	534	565	632	672	751	797
36	617	673	706	752	785	841	866
42	650	715	743	815	842	906	934
48	687	752	793	863	894	946	1003
60	750	841	881	971	1012	1097	1142

Sunset Product Information:

Templates required on non-perfect Sunset Arches. See page 151.

PRODUCT INFORMATION		
	See Page 49 for detailed information.	
DESIGN UPGRADES		
	Scotchgard Stain Protector	Add \$38 per shade
	6 Foot Expandable Pole	Add \$44
	12 Foot Expandable Pole	Add \$54

Color Lux® Cellular Shades

PRICING

COLORLUX® CELLULAR SHADES

**Color Lux® Linen Weave, Aspen,
Verona Textures & Boutique Light Filtering
Fabric Wrapped or Designer Metallic Hardware Included**

**Price Group 9
Trapezoids and Octagons**

Length In Inches	Width In Inches				
	24	30	36	42	48
36	510	539	575	614	648
42	528	562	601	643	681
48	543	583	629	673	713
54	561	603	653	700	746
60	579	626	680	729	778
66	597	648	706	759	815
72	614	667	729	790	849

**Color Lux® Linen Weave, Verona Textures
& Boutique Room Darkening**

**Price Group 10
Trapezoids and Octagons**
Fabric Wrapped or Designer Metallic Hardware Included

Length In Inches	Width In Inches				
	24	30	36	42	48
36	656	694	741	791	836
42	680	724	775	829	879
48	699	751	811	868	920
54	723	777	842	903	963
60	746	807	877	941	1005
66	769	836	911	980	1053
72	791	860	941	1020	1097

PRODUCT INFORMATION	
	See page 51 for detailed information. Width, length and one side are required measurements for Octagon Shades. Trapezoid orders must be faxed in with a diagram that includes the measurements for 4 sides.
DESIGN UPGRADES	
Scotchgard Stain Protector	Add \$38 per shade

Color Lux® Cellular Shades
PRICING

**Color Lux® Linen Weave, Aspen,
Verona Textures & Boutique Light Filtering**

Price Group 11
Mezzo Motorized Skylights
White Rail and White Track

		Width In Inches				
		24	30	36	42	48
Length In Inches	36	457	517	575	642	695
	42	484	549	622	687	761
	48	509	588	659	735	815
	54	538	621	702	780	880
	60	558	654	740	828	944
	66	588	684	777	870	1005
	72	621	723	811	904	1059

Be sure to add the Simplicity motor surcharges and upgrades to the grid above.

**Color Lux® Linen Weave, Verona Textures
& Boutique Room Darkening**

Price Group 12
Mezzo Motorized Skylights
White Rail and White Track

		Width In Inches				
		24	30	36	42	48
Length In Inches	36	587	665	741	828	897
	42	622	707	802	886	983
	48	655	758	850	949	1053
	54	693	801	906	1007	1137
	60	719	843	955	1070	1220
	66	758	882	1003	1124	1300
	72	801	933	1048	1168	1370

Be sure to add the Simplicity motor surcharges and upgrades to the grid above.

MOTORIZED	UPGRADES	ADD	
Simplicity Rechargeable Motorization System	Motor and Battery Wand	\$368	For More Information Page 28-30
	Simplicity 5 Channel Remote	\$44	
	Simplicity 6 Channel Remote/Timer	\$72	
	Simplicity 14 Channel White Remote	\$72	
	Plug-In Charger for Rechargeable Li-Ion	\$30	
Simplicity Smart Controller System	NEO Controller	\$363	For More Information Page 35
	NEO Application for Mobile Devices	FREE	

Color Lux® Cellular Shades

PRICING

COLORLUX® CELLULAR SHADES

**Color Lux® Linen Weave, Aspen,
Verona Textures & Boutique Light Filtering**

**Price Group 13
Soprano Skylights**

		Width In Inches					
		26	30	34	38	42	48
Length In Inches	30	567	603	641	676	712	753
	36	611	653	693	733	774	816
	42	655	703	746	790	837	883
	48	703	753	802	846	896	950
	54	746	805	855	904	955	1013
	60	794	855	907	963	1015	1078
	72	886	949	1013	1077	1140	1213

**Color Lux® Linen Weave,
Verona Textures & Boutique Room Darkening**

**Price Group 14
Soprano Skylights**

		Width In Inches					
		26	30	34	38	42	48
Length In Inches	30	738	784	834	879	926	979
	36	795	849	901	953	1007	1061
	42	852	914	970	1027	1089	1148
	48	914	979	1043	1100	1165	1235
	54	970	1047	1112	1176	1242	1317
	60	1033	1112	1180	1252	1320	1402
	72	1152	1234	1317	1401	1482	1577

PRODUCT INFORMATION		
	See Page 56 for detailed information.	
DESIGN UPGRADES		
	Scotchgard Stain Protector	Add \$38 per shade
	6 Foot Expandable Pole	Add \$44
	12 Foot Expandable Pole	Add \$54

Color Lux® Cellular Shades

PRICING

**Color Lux® Linen Weave, Aspen,
Verona Textures & Boutique Light Filtering**

Price Group 15

**Non-Movable French Door Decors
Fabric Wrapped or Designer Metallic Hardware Included**

		Width In Inches				
		12	18	24	30	36
Length In Inches	36	123	130	136	150	167
	42	130	137	144	161	177
	48	136	144	151	170	191
	54	144	152	159	179	204
	60	152	160	168	190	214
	66	159	168	176	201	228
	72	165	174	183	209	239
	78	172	182	191	219	249
	84	178	188	197	229	260
	90	186	196	206	238	272
	96	190	201	211	246	283

**Color Lux® Linen Weave, Verona Textures
& Boutique Room Darkening**

Price Group 16

**Non-Movable French Door Decor
Fabric Wrapped or Designer Metallic Hardware Included**

		Width In Inches				
		12	18	24	30	36
Length In Inches	36	153	162	170	188	210
	42	162	171	180	203	223
	48	171	181	190	214	242
	54	180	190	200	226	258
	60	191	202	212	240	271
	66	200	211	222	255	290
	72	208	220	231	265	304
	78	218	230	242	278	317
	84	225	237	249	291	331
	90	235	248	261	303	347
	96	242	255	268	313	361

PRODUCT INFORMATION		
	See Page 58 for detailed information.	
DESIGN UPGRADES		
	Scotchgard Stain Protector	Add \$38 per shade
	6 Foot Expandable Pole	Add \$44
	12 Foot Expandable Pole	Add \$54

Color Lux® Cellular Shades

PRICING

COLORLUX® CELLULAR SHADES

**Color Lux® Linen Weave, Aspen,
Verona Textures & Boutique Light Filtering
Fabric Wrapped or Designer Metallic Hardware Included**

**Price Group 17
Movable French Door Decors**

		Width In Inches				
		12	18	24	30	36
Length In Inches	36	222	234	245	270	301
	42	234	247	260	290	319
	48	245	260	272	306	344
	54	260	274	287	323	368
	60	274	288	303	342	386
	66	287	303	317	362	411
	72	297	314	330	377	431
	78	310	328	344	395	449
	84	321	339	355	413	468
	90	335	353	371	429	490
	96	342	362	380	443	510

**Color Lux® Linen Weave, Verona Textures
& Boutique Room Darkening**

**Price Group 18
Movable French Door Decor**

Fabric Wrapped or Designer Metallic Hardware Included

		Width In Inches				
		12	18	24	30	36
Length In Inches	36	276	292	306	339	378
	42	292	308	324	366	402
	48	308	326	342	386	436
	54	324	342	360	407	465
	60	344	364	382	432	488
	66	360	380	400	459	522
	72	375	396	416	477	548
	78	393	414	436	501	571
	84	405	427	449	524	596
	90	423	447	470	546	625
	96	436	459	483	564	650

PRODUCT INFORMATION		
	See Page 58 for detailed information.	
DESIGN UPGRADES		
	Top Down-Bottom Up	Add \$175
	Scotchgard Stain Protector	Add \$38 per shade
	6 Foot Expandable Pole	Add \$44
	12 Foot Expandable Pole	Add \$54

Color Lux® Cellular Shades

STANDARD CORD LOCK SHADES HARDWARE SYSTEM



Cord Lock Rail

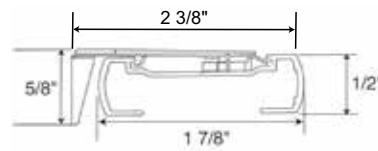

Cord Lock Rail

- Depth of rail: 1 7/8"
- Depth of rail and bracket: 2 3/8"
- Height: 1/2"
- Height of bracket: 5/8"

Hardware Features	
Fabric Wrapped	Fabric used is same fabric as the shade. Back of rail is white to outside. Color coordinated end caps with white cord and tassel
Designer Metallic	<ul style="list-style-type: none"> • Oil Rubbed Bronze head and bottom rails with bronze colored tassel, end caps and white cord. • Brushed Nickel head and bottom rails and end caps with coordinating tassel and white cord.

Mounting Dimensions	Cord Lock Rail
Minimum Shallow Mount	3/4"
Minimum Flush Inside Mount	2 3/8"
Minimum Outside Mount	3/4"
Minimum Side Mount	1 3/8"
Recommended Side Mounting Method	<ul style="list-style-type: none"> • See figure B (pg 19) for recommended mounting method for side mount shades • Width limit for side mount brackets is 48"

Finished Dimensions	
Inside and Side Mount	
	<ul style="list-style-type: none"> • Fabric will measure ordered width less: 3/8" • Head rail* will measure ordered width less: 3/16"
Outside Mount	
	<ul style="list-style-type: none"> • Fabric will measure ordered width • Head rail* will measure ordered width plus: 3/16"
Exact (End Cap to End Cap) Mount	
	<ul style="list-style-type: none"> • Fabric will measure ordered width less: 3/16" • Head rail* will measure ordered width

* Head rail measurements include endcaps.
Width and length measurements may vary +/- 1/8"

Color Lux® Cellular Shades

STANDARD CORD LOCK SHADES HARDWARE SYSTEM

COLORLUX® CELLULAR SHADES

Applications

- Standard Rectangular
- Day-Night
- Trapezoids and Octagons
- Top Down - Bottom Up
- Two-On-One Head Rail

Highlights Cornice Valance

Add a designer finishing touch to a cellular shade with a Highlights Cornice Valance. See page 62 for details.

Things to Consider

- If child safety is a concern, consider cordless options: Cordless Ultra, Cordless Lift & Lock or Motorization.
- Larger shades can be difficult to operate. Consider Cord Loop, Cordless Ultra or Motorization hardware.
- If privacy is an issue, consider Top Down-Bottom Up options.

Recommended Mounting Method for Side Mount Shades

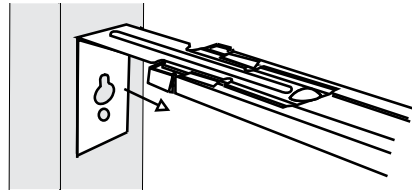

Figure B

EZ Level on Cellular Shades

EZ Level makes quick work of leveling without cords to cut or tuck into a rail. See page 62 for details.

Day-Night Shades

See pages 60-61 for more information.

Specialties (Trapezoids and Octagons)

See pages 51-52 for more information.



Color Lux® Cellular Shades
CORD LOOP HARDWARE SYSTEM

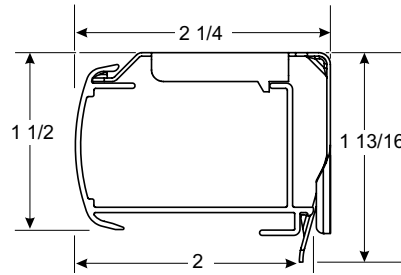

Cord Loop Rail Dimensions

- Depth of rail: 2"
- Depth of rail and bracket: 2 1/4"
- Height of rail: 1 1/2"
- Height of bracket: 1 13/16"

Hardware Features	
Fabric Wrapped	Fabric used is same fabric as the shade. Back of rail is white to outside. Clutch cover will be white. Frosted clear with fabric insert end caps with white cord.
Designer Metallic	<ul style="list-style-type: none"> • Oil Rubbed Bronze head and bottom rails with bronze colored end caps and cord. • Brushed Nickel head and bottom rails, end caps with white cord.

Mounting Dimensions	Cord Loop Hardware System
Minimum Shallow Mount	1/2"
Minimum Flush Inside Mount	2 1/4"
Minimum Outside Mount	7/8"
Minimum Side Mount	1 1/4"
Recommended Side Mounting Method	<ul style="list-style-type: none"> • See figure A (pg 21) for recommended mounting method for side mount shades • Width limit for side mount brackets is 48"

Finished Dimensions	
Inside Mount	
	<ul style="list-style-type: none"> • Fabric will measure ordered width less: 3/8" • Head rail* will measure ordered width less: 3/16"
Outside Mount	
	<ul style="list-style-type: none"> • Fabric will measure ordered width • Head rail* will measure ordered width plus: 3/16"
Side Mount	
	<ul style="list-style-type: none"> • Fabric will measure ordered width less: 7/8" • Head rail* will measure ordered width less: 1 1/16"
Exact (End Cap to End Cap) Mount	
	<ul style="list-style-type: none"> • Fabric will measure ordered width less: 3/16" • Head rail* will measure ordered width

* Head rail measurements include endcaps. Width and length measurements may vary +/- 1/8"

Color Lux® Cellular Shades

CORD LOOP HARDWARE SYSTEM

COLORLUX® CELLULAR SHADES

Applications

- Standard Rectangular
- Two-On-One Head Rail
- Top Down - Bottom Up

Cord Loop Hardware System Features

Cord loops are available 2' to 15' lengths in 1' intervals. Please specify length when ordering. Standard loop sizes are as follows:

Shade Length	Standard Loop
Up to and including 26 ⁷ / ₈ "	1' (12")
27" to 39 ⁷ / ₈ "	2' (24")
40" to 59 ⁷ / ₈ "	3' (36")
60" to 83 ⁷ / ₈ "	4' (48")
84" to 107 ⁷ / ₈ "	5' (60")
108" and greater	6' (72")

Recommended Mounting Method for Side Mounting Shades

Width limit for side mount brackets is 48".

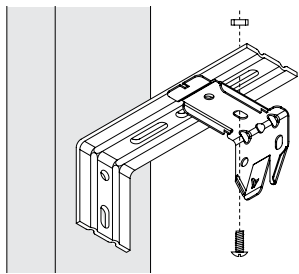

Cord Loop Hardware
Cordless Ultra Hardware
Cordless Ultra Top Down - Bottom Up Hardware

Figure A

Refer to the installation instructions on Comfortex.com/comfortex-dealers or the OnDemand Mobile Library for further details on side mounting shades.

Ordering Information for Cord Loop Hardware Shades

Standard Rectangular

- Specify IB or OB mount, rail color and left or right lift cord.
- Specify cord loop length when ordering.

Top Down - Bottom Up

- Specify IB or OB mount and rail color. Middle rail will match the top and bottom rails.
- Specify cord loop length when ordering.
- Controls are the right cord loop operates the middle rail and left cord loop operates the bottom. Reverse controls are not available.

Two-On-One Head Rail

- Two-On-One Head Rail Shades operate as two separate shades on one head rail.
- Specify IB or OB mount and rail color.
- Specify panel sizes.
- Specify cord loop length when ordering.
- 3/8" Space between panels.
- Fabric wrapped Two-On-One Shades will have a seam in the center of the rail due to the wide width.

Highlights Cornice Valance

Add a designer finishing touch to a cellular shade with a Highlights Cornice Valance. See page 62 for details.

EZ Level on Comfortex Cellular Shades

EZ Level makes quick work of leveling without cords to cut or tuck into a rail. No special tools needed – just use a nickel, quarter or penny to adjust plug on the bottom rail.

EZ Level is standard on all Cellular and Pleated Shades with the following hardware systems:
Standard Cord Lock, Cordless Ultra, Cord Loop Simplicity Motorized Systems

EZ Level is not available with Cordless Lift & Lock.

How does EZ Level work?

- Slightly raise the bottom rail you want to level.
- Insert a coin or flat head screwdriver into the adjustment screw and turn it.
- Turn the adjustment screw clockwise or counter clockwise to make slight adjustments up or down. One quarter turn of the adjustment screw will move the bottom rail up or down 1/4".
- Lower the rail to check the level and make further adjustments if necessary.



Color Lux® Cellular Shades
CORDLESS ULTRA HARDWARE SYSTEM

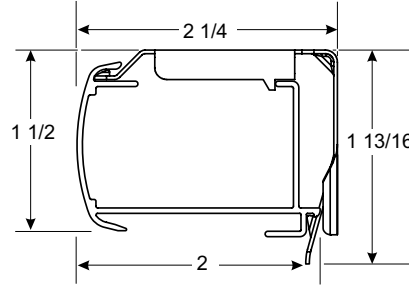

Cord Loop Rail Dimensions

- Depth of rail: 2"
- Depth of rail and bracket: 2 1/4"
- Height of rail: 1 1/2"
- Height of bracket: 1 13/16"

Hardware Features	
Fabric Wrapped	Fabric used is same fabric as the shade. Back of rail is white to outside. Frosted clear with fabric insert end caps with white cord.
Designer Metallic	<ul style="list-style-type: none"> • Oil Rubbed Bronze head and bottom rails with bronze colored end caps and cord. • Brushed Nickel head and bottom rails, end caps.
Mounting Dimensions	
Cord Loop Hardware System	
Minimum Shallow Mount	1/2"
Minimum Flush Inside Mount	2 1/4"
Minimum Outside Mount	7/8"
Minimum Side Mount	1 1/4"
Recommended Side Mounting Method	<ul style="list-style-type: none"> • See figure A, page 21 for recommended mounting method for side mount shades • Width limit for side mount brackets is 48"
Finished Dimensions	
Inside Mount	
	<ul style="list-style-type: none"> • Fabric will measure ordered width less: 3/8" • Head rail* will measure ordered width less: 3/16"
Outside Mount	
	<ul style="list-style-type: none"> • Fabric will measure ordered width • Head rail* will measure ordered width plus: 3/16"
Side Mount	
	<ul style="list-style-type: none"> • Fabric will measure ordered width less: 7/8" • Head rail* will measure ordered width less: 1 1/16"
Exact (End Cap to End Cap) Mount	
	<ul style="list-style-type: none"> • Fabric will measure ordered width less: 3/16" • Head rail* will measure ordered width
* Head rail measurements include endcaps. Width and length measurements may vary +/- 1/8"	

Color Lux® Cellular Shades

CORDLESS ULTRA HARDWARE SYSTEM

COLORLUX® CELLULAR SHADES

Applications

- Standard Rectangular
- Top Down - Bottom Up
- Two-On-One Head Rail

Things to Consider

- Is the top of your window out of reach? You can order an extension pole to reach but it can still be tricky. You may want to consider Cord Loop or Motorized hardware.
- For shades mounted on doors, you may want to order hold down brackets.
- If privacy is an issue, consider Top Down-Bottom Up options.

Ordering Information for Cordless Ultra Hardware Shades

Standard Rectangular

- Specify IB or OB mount and rail color.

Top Down - Bottom Up

- Specify IB or OB mount and rail color. Middle rail will match the head and bottom rails.

Accessories

- 6' Expandable Pole:
- 12' Expandable Pole:

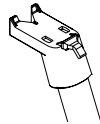

Specially designed pole end fits into the handle on the bottom rail and allows for easy operation.

Cordless Ultra and Cordless Ultra Top Down - Bottom Up Hardware Features

- Children and pets have safer surroundings in homes that have window shades without operating cords, reducing the risk of strangulation.
- Cordless Ultra and Cordless Ultra Top Down - Bottom Up Shades can be raised or lowered with a gentle push or pull on the rail handle.
- Cordless Ultra Top Down - Bottom Up Shades feature two moving rails.
- Order an operating pole for out of reach applications.



Fabric Wrapped Head Rail and Designer Metallic Head Rails.

Cordless Ultra Shade Operation

Cordless shades should be operated from the handle located in the center of the bottom rail. Using the handle will aid in smooth and easy shade operation. Two handles are supplied on wider width shades.

To lower the shade, pull down on the handle which is secured to the bottom rail and guide the rail to desired position (Figure A). For out of reach applications, an optional extension pole should be used.

To raise the shade, push the bottom rail up using the handle on the bottom rail and guide the rail to the desired position. The shade will hold any position when the bottom rail is released. Raise the shade slowly and steadily to allow the shade to stack evenly (Figure B).

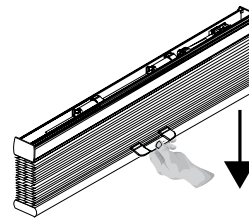

Figure A

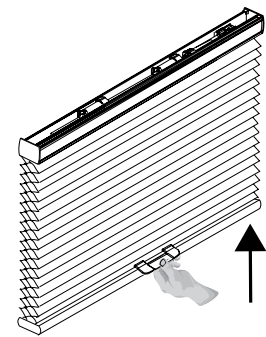

Figure B



Clear Cordless Handle

Recommended Mounting Method for Side Mounting Shades

See Page 21.

Highlights Cornice Valance

Add a designer finishing touch to a cellular shade with a Highlights Cornice Valance. See page 62 for details.

EZ Level on Cellular Shades

EZ Level makes quick work of leveling without cords to cut or tuck into a rail. See page 62 for details.

Color Lux® Cellular Shades
CORDLESS LIFT & LOCK HARDWARE SYSTEM



Cordless Lift & Lock Head Rail

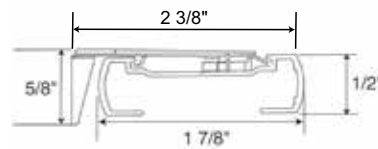

Cordless Lift & Lock Rail

- Depth of rail: 1 7/8"
- Depth of rail and bracket: 2 3/8"
- Height: 1/2"
- Height of bracket: 5/8"

Hardware Features	
Hardware	<ul style="list-style-type: none"> • Fabric wrapped head, middle and bottom rails. Shades will have a coordinated or white push button/handle and end caps on the middle/bottom rail. Refer to coordination chart in the Dealer Resource Center in the Fabrication section online. • Fabric used to cover the rails is the same fabric as the shade. The back of the rail will be white to the outside.
Upgrades	
Designer Metallic Upgrade	<ul style="list-style-type: none"> • Smooth faced Designer Oil Rubbed Bronze Metallic head, middle and bottom rail and end caps. • Oil Rubbed Bronze push button/handle on the middle and bottom rails.
Mounting Dimensions	
Lift & Lock Head Rail	
Minimum Shallow Mount	3/4"
Minimum Flush Inside Mount	2 1/2"
Minimum Outside Mount	3/4"
Minimum Side Mount	1 3/8"
Recommended Side Mounting Method	<ul style="list-style-type: none"> • See figure A (pg 21) for recommended mounting method for side mount shades • Width limit for side mount brackets is 48"
Finished Dimensions	
Inside and Side Mount	
	<ul style="list-style-type: none"> • Fabric will measure ordered width less: 3/8" • Head rail* will measure ordered width less: 3/16"
Outside Mount	
	<ul style="list-style-type: none"> • Fabric will measure ordered width • Head rail* will measure ordered width plus: 3/16"
Exact (End Cap to End Cap) Mount	
	<ul style="list-style-type: none"> • Fabric will measure ordered width less: 3/16" • Head rail* will measure ordered width
<p>* Head rail measurements include endcaps. Width and length measurements may vary +/- 1/8"</p>	

Color Lux® Cellular Shades

CORDLESS LIFT & LOCK HARDWARE SYSTEM

COLORLUX® CELLULAR SHADES

Cordless Lift & Lock Shades Hardware System Bottom Rail Dimensions

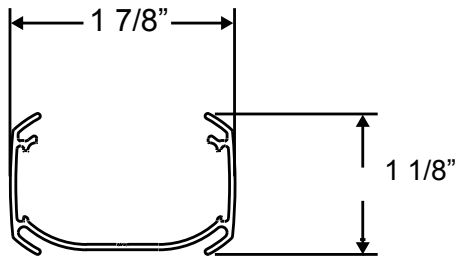

- Depth of rail: 1 7/8"
- Height of rail: 1 1/8"

Applications

- Standard Rectangular
- Top Down-Bottom Up
- Two-On-One Head rail

Important Operating Note on Cordless Lift & Lock Shades

- To operate a Cordless Lift & Lock Shade, the middle or bottom rails must be accessible. An extension pole is not available for Cordless Lift & Lock Shades.
- If the bottom or middle rail is not accessible, you may want to consider Cord Loop, Cordless Ultra or Motorized hardware. An extension pole is not available for Cordless Lift & Lock Shades.

Cordless Lift & Lock Hardware Features

- Children and pets have safer surroundings in homes that have window shades without operating cords, reducing the risk of strangulation.
- Cordless Lift & Lock Shades can be raised or lowered by pressing the button located on the bottom rail and guiding the rail into the desired location.

Leveling the Bottom Rails

Each Cordless Lift & Lock Shade includes a skew adjustment leveling tool hidden in the bottom rail of each shade.

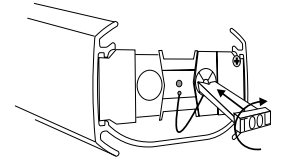

To level the bottom rail, remove the bottom rail end cap to access the tool which allows you to adjust the placement of the bottom rail. Adjustment instructions are supplied with each shade.

Ordering Information for Cordless Lift & Lock Shades

Standard Rectangular

- Specify IB or OB mount and rail color.

Cordless Lift & Lock Shade Operation

Cordless Lift & Lock Shades are operated using the push button handle located in the center of the bottom rail.

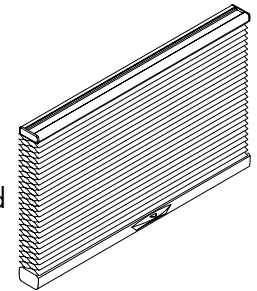

To raise or lower the shade; press the button on the shade handle, and guide the rail to desired position. Release the button to lock the shade into place.

The shade will hold any position when the button is released. Raise the shade slowly and steadily to allow the shade to stack evenly.

Recommended Mounting Method for Side Mounting Shades

See Page 21.

Highlights Cornice Valance

Add a designer finishing touch to a cellular shade with a Highlights Cornice Valance. See page 62 for details.



Fabric Wrapped Head Rail with White End Caps



Fabric Wrapped Bottom Rail with White push button/handle



Oil Rubbed Bronze Head Rail and End Caps



Oil Rubbed Bottom Rail and push button/handle

Cellular Shade Head Rail Options

12V NON-RECHARGEABLE SIMPLICITY MOTORIZED CELLULAR SHADES

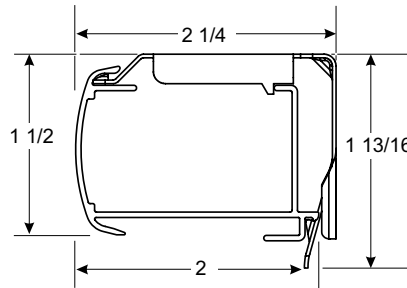

Simplicity Motorized Rail Dimensions

- Depth of rail: 2"
- Depth of rail and bracket: 2 1/4"
- Height of rail: 1 1/2"
- Height of bracket: 1 13/16"

Hardware Features	
Standard Hardware	<ul style="list-style-type: none"> • Fabric Wrapped head and bottom rails. Head rail and Bottom rails will have frosted end caps with fabric inserts. • Fabric used to cover the rails is the same fabric as the shade. The back of the rail will be white to the outside.
Simplicity Remote	Upper and lower limit stops pre-programmed, Intermediate stop "favorites" position can be set on site.
Upgrades	
Designer Metallic Upgrade	<ul style="list-style-type: none"> • Smooth faced Designer Oil Rubbed Bronze head, middle, bottom rails and end caps • Smooth faced Designer Brushed Nickel head, middle, bottom rails and end caps

Mounting Dimensions	Simplicity Motorized Hardware System
Minimum Shallow Mount	1/2"
Minimum Flush Inside Mount	2 1/4"
Minimum Outside Mount	7/8"
Minimum Side Mount	1 1/4"
Recommended Side Mounting Method	<ul style="list-style-type: none"> • See page 50 for recommended mounting method for side mount shades • Width limit for side mount brackets is 48"

Finished Dimensions	
Inside Mount	
	<ul style="list-style-type: none"> • Fabric will measure ordered width less: 3/8" • Head rail* will measure ordered width less: 3/16"
Outside Mount	
	<ul style="list-style-type: none"> • Fabric will measure ordered width • Head rail* will measure ordered width plus: 3/16"
Side Mount	
	<ul style="list-style-type: none"> • Fabric will measure ordered width less: 7/8" • Head rail* will measure ordered width less: 1 1/16"
Exact (End Cap to End Cap) Mount	
	<ul style="list-style-type: none"> • Fabric will measure ordered width less: 3/16" • Head rail* will measure ordered width
* Head rail measurements include endcaps. Width and length measurements may vary +/- 1/8"	

Cellular Shade

12V NON-RECHARGEABLE SIMPLICITY MOTORIZED CELLULAR SHADES

Simplicity Motors

The Simplicity Motor program features a battery powered motor utilizing a single battery wand or plug-in DC transformer. Simplicity motors are compact and use a radio frequency remote to raise or lower the shades.

Motorized Lift Systems are not offered on sizes within the shaded area on the Standard Rectangular price grids.

- Length measurements may vary +/- 1/8".

Applications

- Standard Rectangular
- Two-On-One Head Rail

EZ Level

Learn about the EZ Level feature on page 62.

Simplicity Motorization Surcharges

The standard Simplicity Motorized Lift System surcharge includes a 12 volt battery wand with eight AA batteries. Remotes are needed to operate the shades. See pricing pages.

Important Simplicity Motorized Shade Operating and Installation Information

- Simplicity Motorized Shades installed into windows with metal casings may have a reduced radio frequency range, or may not operate at all, depending on the application.
- Do not let the antenna on the motor touch any metal objects. This may interfere with signals from the remote control.

SIMPLICITY MOTORIZATION PRICING EXAMPLE:

Linen Weave	
Light Filtering 42" x 60" Shade:	\$422.00
Simplicity Motor Surcharge:	\$368.00
Simplicity Remote Control:	\$44.00
Total List Price:	\$834 .00

Simplicity Battery Wand

Batteries are needed to operate Simplicity motors. The battery wand can be clipped to the head rail or wall or ceiling mounted utilizing white battery wand clips. The 12 volt battery wand measures 17 1/4", and comes with eight AA alkaline batteries, and is white in color.

The battery wire is 10" long. A 48" extension wire is available.



Simplicity Motor Battery Life and Replacement

Eight alkaline batteries are included with the wand.

The battery life will vary based on the type of window covering selected, the size and weight of the window covering and the number of times you operate the shade on a daily basis. For example, a 36" x 60" single honeycomb shade operated twice daily will commonly have a battery life which lasts up to 18 months.

Comfortex will warranty batteries for up to 3 months from date of purchase.

Simplicity Hand Held Remotes

The **5 Channel (5C) remote** can operate up to five shades individually or 5 groups. Simplicity Rechargeable Motorized Cellular Shades are programmed at the factory with the "up and down" limits. The shades are **UNLINKED** from the remote so they are not able to operate during shipping. Each shade should be installed **after** linking it to the remote.



Simplicity 5C remotes and holders are white or black in color. The remote comes with a holder which can be mounted to a wall for easy storage. The range of the remote is approximately 80 feet.

A **6 Channel (6C) timer remote** is also available. See page 30 for more information.

A **14 Channel (14C) remote** is also available. This remote is required for TDBU motorization but can be utilized on all Simplicity motorized shades. See page 32 for more information.

DC Power Supply/Transformer

12 Volt DC power supply/transformer is available and requires a standard power outlet to power the motor. The transformer is an alternative to a battery wand. Each transformer can power a single shading. The power supply must plug in to the motor. The DC power supply is white and comes with a 80" wire. The dimensions are 1 7/8" wide x 3 1/4" long x 1 1/4" deep



Color Lux® Cellular Shades

7.4V RECHARGEABLE SIMPLICITY MOTORIZED HARDWARE SYSTEM

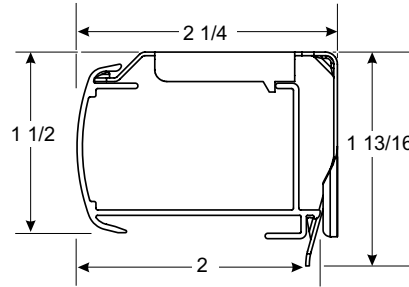

Simplicity Rechargeable Rail Dimensions

- Depth of rail: 2"
- Depth of rail and bracket: 2 1/4"
- Height of rail: 1 1/2"
- Height of bracket: 1 13/16"

Hardware Features	
Standard Hardware	<ul style="list-style-type: none"> • Fabric Wrapped head and bottom rails. Head rail and Bottom rails will have frosted end caps with fabric inserts. • Fabric used to cover the rails is the same fabric as the shade. The back of the rail will be white to the outside.
Simplicity Remote	Upper and lower limit stops pre-programmed, Intermediate stop "favorites" position can be set on site.
Upgrades	
Designer Metallic Upgrade	<ul style="list-style-type: none"> • Smooth faced Designer Oil Rubbed Bronze head, middle, bottom rails and end caps • Smooth faced Designer Brushed Nickel head, middle, bottom rails and end caps

Mounting Dimensions	Simplicity Rechargeable Motorization Hardware System
Minimum Shallow Mount	1/2"
Minimum Flush Inside Mount	2 1/4"
Minimum Outside Mount	7/8"
Minimum Side Mount	1 1/4"
Recommended Side Mounting Method	<ul style="list-style-type: none"> • See page 21 for recommended mounting method for side mount shades • Width limit for side mount brackets is 48"

Finished Dimensions	
Inside Mount	
	<ul style="list-style-type: none"> • Fabric will measure ordered width less: 3/8" • Head rail* will measure ordered width less: 3/16"
Outside Mount	
	<ul style="list-style-type: none"> • Fabric will measure ordered width • Head rail* will measure ordered width plus: 3/16"
Side Mount	
	<ul style="list-style-type: none"> • Fabric will measure ordered width less: 7/8" • Head rail* will measure ordered width less: 1 1/16"
Exact (End Cap to End Cap) Mount	
	<ul style="list-style-type: none"> • Fabric will measure ordered width less: 3/16" • Head rail* will measure ordered width

* Head rail measurements include endcaps. Width and length measurements may vary +/- 1/16"

Color Lux® Cellular Shades

7.4V RECHARGEABLE SIMPLICITY MOTORIZED HARDWARE SYSTEM

COLORLUX® CELLULAR SHADES

Rechargeable Simplicity Motors

The Simplicity Motor program features a battery powered motor utilizing a rechargeable battery hidden inside the shade head rail. Simplicity motors are compact and use a radio frequency remote to raise or lower the shades.

Rechargeable Motorized Lift Systems are not offered on sizes within the shaded area on the Standard Rectangular price grids.

Applications

- Standard Rectangular
- Two-On-One Head Rail

Please Note

- Motorized shades less than 24" in width are limited to a maximum of 60" in length.

EZ Level

Learn about the EZ Level feature on page 62.

Rechargeable Simplicity Motorization Surcharges

The Rechargeable Simplicity Motorized Lift System surcharge includes a rechargeable battery. Remotes are needed to operate the shades. Refer to pricing pages.

Important Simplicity Motorized Shade Operating and Installation Information

- Simplicity Motorized Shades installed into windows with metal casings may have a reduced radio frequency range, or may not operate at all, depending on the application.
- Do not let the antenna on the motor touch any metal objects. This may interfere with signals from the remote control.

Simplicity Rechargeable Battery

The rechargeable battery is concealed in the head rail of the shade. A charger is required for the rechargeable battery. The rechargeable battery comes fully charged from the factory.

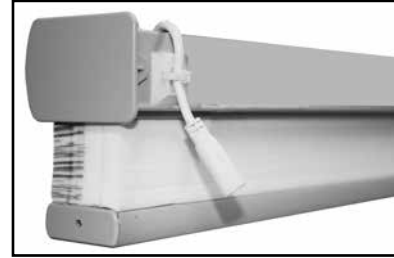

Charging Port on Back of Head rail.

SIMPLICITY RECHARGEABLE BATTERY WAND PRICING EXAMPLE:

Linen Weave	
Light Filtering 42" x 60" Shade:	\$422.00
Simplicity Rechargeable Surcharge:	\$368.00
Charger for Rechargeable :	\$30.00
Simplicity Remote Control:	\$44.00
Total List Price:	\$864.00

Color Lux® Cellular Shades

7.4V RECHARGEABLE SIMPLICITY MOTORIZED HARDWARE SYSTEM

Simplicity Rechargeable Battery Life

Rechargeable batteries are included with the motor.

The average battery charge will last 6-12 months based on an average sized shade raised and lowered once per day. The life of the battery charge will vary based on the type of window covering selected, the size and weight of the window covering and the number of times the shade is operated on a daily basis.

The battery can be recharged up to 500 times. It takes approximately 5 hours to recharge the motor when fully depleted.

Ordering Information for Rechargeable Motorized Cellular Shades

Simplicity Motor Option

- Specify IB or OB mount and rail color.
- Specify remote and other accessories if needed.
- Specify one or more battery chargers.

Please Note:

- Not all motors run at the same rate of speed.
- Simplicity motors have a "Favorites" or "MY" position setting. If the homeowner wants to set several shades at the same intermediate position, follow instructions provided with installation manual.
- Simplicity Rechargeable Motorized Cellular Shades are programmed at the factory with the "up and down" limits. The shades are **UNLINKED** from the remote so they are not able to operate during shipping. Each shade should be installed **before** linking it to the remote.
- **REMEMBER: Order at least one charger if ordering rechargeable motors.**

Simplicity Motorized Shade Warranty

Please see page 154 for complete Comfortex warranty information.

Battery Charger

8.4 Volt charger requires a standard power outlet to recharge the battery wand. Must specify charger when ordering a Simplicity Rechargeable Wand Shade. The charger plugs into the charger port. The charger is black and comes with a 156" (13') wire. The dimensions are 1" wide x 2½" length x 1¾" deep.



Simplicity Motor Hand Held Remotes 5 Channel Remote

The **5 Channel (5C) remote** can operate up to five shades individually or 5 groups. Simplicity Rechargeable Motorized Cellular Shades are programmed at the factory with the "up and down" limits. The shades are **UNLINKED** from the remote so they are not able to operate during shipping. Each shade should be installed **after** linking it to the remote.



Simplicity 5C remotes and holders are white or black in color. The remote comes with a holder which can be mounted to a wall for easy storage. The range of the remote is approximately 80 feet.

6 Channel Timer Remote

The **6 Channel (6C) timer remote** combines the functionality of a six channel hand-held control with the convenience of a programmable timer.

- The 6C timer remote allows for 18 different scheduled actions.
- Manual function disables the timer and the remote then operates as a held remote.



Simplicity 6C remotes and holders are white in color. The remote comes with a holder which can be mounted to a wall for easy storage. The range of the remote is approximately 80 feet.

Simplicity Rechargeable Motorized Cellular Shades are programmed at the factory with the "up and down" limits. The shades are **UNLINKED** from the remote so they are not able to operate during shipping. Each shade should be installed **after** linking it to the remote.

A **14 Channel (14C) remote** is also available. This remote is required for TDBU motorization but can be utilized on all Simplicity motorized shades. See page 32 for more information.

Simplicity Motor Hand Held Remotes Operation

Press the up or down button on the remote to raise or lower the shade to your desired position.

To reprogram channel assignments, please refer to the installation instructions and/or view the video at: comfortex.com/comfortex-dealers.

The Simplicity remotes utilize one 3V battery. Batteries are included. Comfortex will warranty batteries for up to 3 months from date of purchase. Batteries are not covered by the warranty.

Color Lux® Cellular Shades

7.4V RECHARGEABLE MOTORIZED TOP DOWN-BOTTOM UP HARDWARE SYSTEM

COLORLUX® CELLULAR SHADES

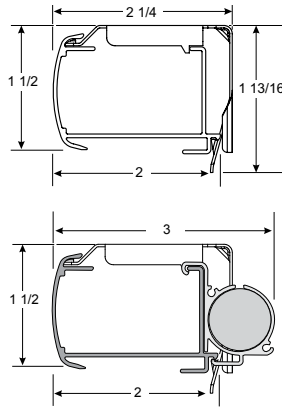

Simplicity Motorized Rail Dimensions

- Depth of rail: 2"
- Depth of rail and bracket: 2 1/4"
- Height of rail: 1 1/2"
- Height of bracket: 1 13/16"

Simplicity Motorized Rail with External Battery Dimensions

- Depth of rail: 2"
- Depth of rail, bracket & battery: 3"
- Height of rail: 1 1/2"
- Height of bracket: 1 13/16"

Hardware Features

Standard Hardware	<ul style="list-style-type: none"> • Fabric Wrapped head, middle and bottom rails. Head rail and Bottom rails will have frosted end caps with fabric inserts. • Fabric used to cover the rails is the same fabric as the shade. The back of the rail will be white to the outside.
TDBU 14 Channel Remote	Upper and lower limit stops pre-programmed.
Upgrades	
Designer Metallic Upgrade	<ul style="list-style-type: none"> • Smooth faced Designer Oil Rubbed Bronze head, middle, bottom rails and end caps • Smooth faced Designer Brushed Nickel head, middle, bottom rails and end caps

Mounting Dimensions

Simplicity Motorized Hardware System

Minimum Shallow Mount	1/2"
Minimum Flush Inside Mount	2 1/4"
Minimum Outside Mount	7/8"
Minimum Side Mount	1 1/4"
Recommended Side Mounting Method	<ul style="list-style-type: none"> • See page 21 for recommended mounting method for side mount shades • Width limit for side mount brackets is 48"

Finished Dimensions

Inside Mount

- Fabric will measure ordered width less: 3/8"
- Head rail* will measure ordered width less: 3/16"

Outside Mount

- Fabric will measure ordered width
- Head rail* will measure ordered width plus: 3/16"

Side Mount

- Fabric will measure ordered width less: 7/8"
- Head rail* will measure ordered width less: 1 1/16"

Exact (End Cap to End Cap) Mount

- Fabric will measure ordered width less: 3/16"
- Head rail* will measure ordered width

* Head rail measurements include endcaps. Width and length measurements may vary +/- 1/8"

Color Lux® Cellular Shades

7.4V RECHARGEABLE MOTORIZED TOP DOWN-BOTTOM UP HARDWARE SYSTEM

Rechargeable Simplicity Motors

The Simplicity Motor program features a battery powered motor utilizing a rechargeable battery hidden inside the shade head rail. If shades are less than 36" in width, an external snap-on battery pack is necessary. *(See picture to right)*

Applications

- Rectangular

EZ Level

Learn about the EZ Level feature on page 62.

Rechargeable Simplicity Motorization Surcharges

The Rechargeable Simplicity Motorized Lift System surcharge includes a rechargeable battery. Remotes are needed to operate the shades. Refer to pricing pages.

Ordering Information for Top Down-Bottom Up Motorized Cellular Shades

Simplicity Motor Option

- Specify IB or OB mount and rail color.
- 14 Channel TDBU Remote is required.
- Specify one or more battery chargers.

Please Note:

- Shades that are 24"-36" in width will have an external battery.
- Shades with an external battery and OB mounted will need spacer blocks.
- Simplicity Rechargeable Motorized Cellular Shades are programmed at the factory with the "up and down" limits set on both moving rails.
- **REMEMBER: Order at least one charger if ordering rechargeable motors.**

Top Down-Bottom Up Simplicity Motor Hand Held 14 Channel Remote

The TDBU remote has 14-channels. Each channel has a setting to operate the middle rail and a setting to operate the bottom rail. The TDBU remote is required for TDBU motors. The **14 Channel TDBU remote** can operate up to fourteen shades individually or 14 groups. Simplicity Rechargeable Motorized Cellular Shades are programmed at the factory with the "up and down" limits. The shades are **UNLINKED** from the remote so they are not able to operate during shipping. Each shade should be installed **after** linking it to the remote.



Simplicity TDBU remotes and holders are white in color. The remote comes with a holder which can be mounted to a wall for easy storage. The range of the remote is approximately 80 feet.

Simplicity Rechargeable Battery

The rechargeable battery is concealed in the head rail of the shade. A charger is required for the rechargeable battery. The rechargeable battery comes fully charged from the factory.

Rechargeable Battery Pack is concealed in the head rail. Minimum width of 36" is required otherwise battery must be mounted externally.

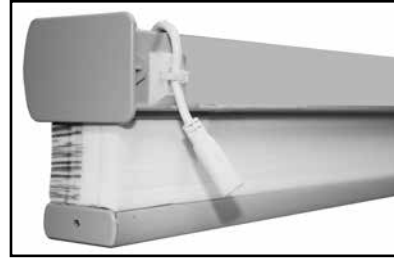

Charging Port on Back of Head rail.



Snap-On external battery for shades under 36" or less in width. Spacer block also shown, required for outside mount.

Battery Charger

8.4 Volt charger requires a standard power outlet to recharge the battery wand. Must specify charger when ordering a Simplicity Rechargeable Wand Shade. The charger plugs into the charger port. The charger is black and comes with a 156" (13') wire. The dimensions are 1" wide x 2½" length x 1¾" deep.



MOTORIZED TOP DOWN-BOTTOM UP PRICING EXAMPLE:	
Linen Weave	
Light Filtering 42" x 60" Shade:	\$422.00
Simplicity Rechargeable Surcharge:	\$589.00
Charger for Rechargeable:	\$30.00
TDBU Remote Control:	\$72.00
Total List Price:	\$1113.00

Color Lux® Cellular Shades

7.4V RECHARGEABLE MOTORIZED TOP DOWN-BOTTOM UP HARDWARE SYSTEM

COLORLUX® CELLULAR SHADES

EZ Charge Extension Wand Option

EZ Charge Extension Wand is the newest innovation in rechargeable motorization. Easily charge your hard to reach Simplicity Rechargeable Shades with the EZ Charge Extension Wand. The wand extends up to 31" in length.

Simple to use! Place the magnetized wand tip on the receiving port to attach. Then plug the charger into the base of the wand. It is that simple!

- EZ Charge Extension Wand can be easily concealed by a valance or drapery panel.
- Great for out of reach windows

EZ Charge Wall Mount Receiver

- The EZ Charge Wall Mount Receiver includes screws and anchors. These can be used for wood or drywall mounting.
- Extension cable plugs into charging port of Simplicity Rechargeable shades.



EZ Charge Wall Mount Receiver Kit | CKIT078
One kit per Simplicity Motorized shade is needed.

EZ Charge Wand

- Wand is 9 1/2" and extends to 31"
Magnetized tip makes connection quick and easy.
- Once wand is in place plug the 8.4v charger into the bottom of the extension wand for charging.

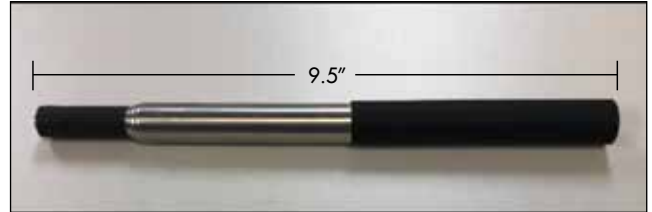

EZ Charge Wand | CKIT077
Order with the EZ Charge Wall Mount Receiver Kit



EZ Charge Receiving Port



Port/Wand Connection

Shade/Blind Product	EZ Charge Wall Mount Receiver List Price	EZ Charge Wand List Price
Cellular	\$22	\$42



Battery Charger



Wand Base

Battery Charger - SOLD SEPARATELY

You must specify charger when ordering a Simplicity Rechargeable Motorized Shade. The charger plugs into the wand base. The 8.4 Volt charger requires a standard power outlet to recharge the motor. The charger is black and comes with a 156" wire. The dimensions are 1" wide x 2 1/2" length x 1 3/4" deep.

Cellular Shade Collection

12V SIMPLICITY LOW VOLTAGE HARDWIRING SYSTEM

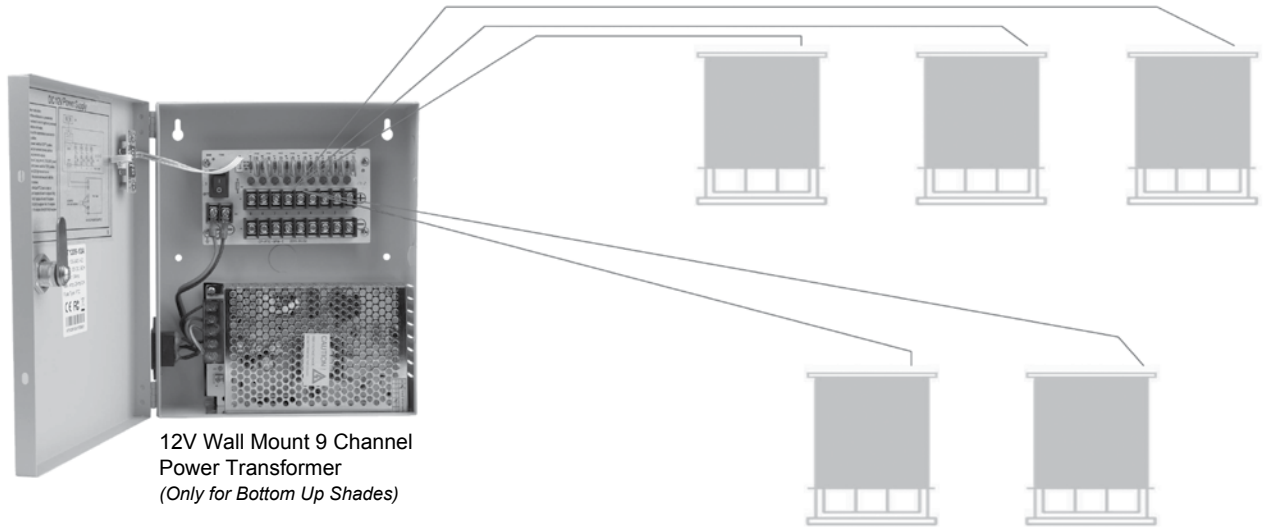

12V Low Voltage Hard Wired

Low Voltage hardwire powered motors are available for Roller Shades, Sheer Shadings and Cellular bottom up shades. The system offers a maintenance-free power option for Simplicity Motorized Shades. Our Simplicity power transformer mounts in a safe dry location (such as your basement), out of sight, and provides power for up to nine individual shades per box.

2 Conductor wires should be pre-installed by a licensed contractor according to local building codes, to connect power from the transformer to the shades.

Simply use the wire adapters provided to connect the power wire to the Simplicity motor power input on the back of the shade, then connect the pre-run wires to the (+ / -) terminal block in the transformer box, and flip on the power switch.

- Product Dimension: 7.875" wide, 9.4" Tall, 2.45" deep
- Converts incoming 120V AC to outgoing 12V for up to 9 shades.

• **Product Description:**

- 12v10a 9ch
- Input Voltage Range : AC90V-264V
- Input Frequency Range : 50Hz-60Hz
- Output Voltage Range : DC12V+/-5%
- Output Current : 10 Ampere
- Output Power : 120 Watt
- Output Ripple&Noise : ≤42MV
- Output Efficiency : ≥83%
- Output Fuse Type : PTC
- Output Fuse Rating : 2A
- Environment Operating Amb.Temp : -30 ~45
20%~90%RH
- Environment Storage Temp : -40 ~85 10%~95%RH
- Plugs into standard household outlet
- Power cord is 56" in length



2 Conductor Wires running to basement 12V Power Transformer



Power port on back of shade



Wires connecting to charging port on Simplicity shade



12V Wall Mount 9 Channel Power Transformer

Color Lux® Cellular Shades
SIMPLICITY SMART CONTROLLER

COLORLUX® CELLULAR SHADES



Simplicity Smart Controller Dimensions

- Width of controller: 2³/₈"
- Length of controller: 2¹⁵/₁₆"
- Height of controller: 1¹/₈"

Simplicity Smart Controller

- Works with Apple and Android devices
- FREE Downloadable Application
- Compatible with previously installed Simplicity Remote Control Shades
- Powered by NEO Smart Blinds App
- Compatible with Amazon Alexa, Google Assistant systems, Control4 and Savant systems

Simplicity Smart Controller

The Simplicity Smart Controller is a small device that you install in your home that allows you to set automatic opening and closing times for all Simplicity motorized shades as well as the ability to control your motorized shades from a phone, tablet or PC from anywhere in world.

The Simplicity Smart Controller will work with any Comfortex remote motorized shade with Simplicity remote control motors purchased after 2012.

The Simplicity Smart Controller plugs into a standard electrical outlet and connects to WiFi and sends signals to your shades using the same radio frequencies as a normal remote control.

How Does The NEO Smart Blinds App Work?

The app uses WiFi or cellular data to send commands over the internet to the Simplicity Smart Controller.

Do I Need Any Other Equipment?

Yes, The location where your shades are installed must have WiFi in order for the Simplicity Smart Controller to work. Additionally, you must have a smartphone or tablet running Android or iOS (eg. iPhone, iPad, Samsung Galaxy S7) and have the NEO Smart Blinds app. installed.

Why Would I Want A Simplicity Smart Controller?

There are two main ways the Simplicity Smart Controller adds additional value to your motorized shades. First, once all of your shades have been added, you can use your smartphone as a single remote for all of your shades that will work anywhere you are regardless of distance from the shade. Secondly, the device allows you to set schedules so your motorized shades automatically open and close without needing to do anything on a day to day basis.

Do I Need To Buy More Than 1 Controller?

The normal use for the Simplicity Smart Controller is to plug it in out of the way and forget it. Since it has roughly the same range as a remote you will want enough devices to allow all shades to be operated without moving the controller. So depending on the layout of the home and location of the shade, you might want multiple devices to have convenient full home coverage.

How Far Is The Range Of A Controller?

You should see a range of approximately 150 ft. However this number might be less depending on the layout of your home. In general we recommend one per a floor of a normal sized home.

Can I Control My Shades From Multiple Devices?

Yes! You can download the NEO Smart Blinds App onto multiple devices, After installing the App. on a new device simply log in with the same email/password on each device and you will have access to control your shades.

Can It Be Used With Already Installed Shades?

Yes! Simply follow the directions in the NEO Smart Blinds app. to add a shade. At the pairing step you can put the shade in pairing mode using the primary remote control for it (or by accessing the button on the shades motor). Adding the shade to the NEO Smart Blinds App. will not affect the normal remote operation.

How Much Does The NEO Smart Blinds App Cost?

The app is a free download, However you must have at least one Simplicity Smart Controller to serve as a bridge between the app and your shades. See page 7.

Color Lux® Cellular Shades

7.4V RECHARGEABLE POWERTOCH MOTORIZED HARDWARE SYSTEM

COLORLUX® CELLULAR SHADES

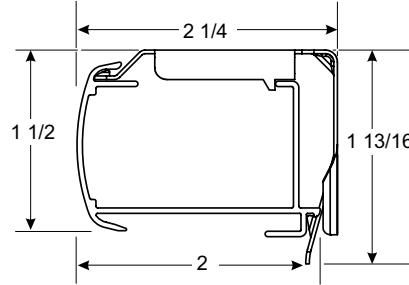

Simplicity Motorized Rail Dimensions

- Depth of rail: 2"
- Depth of rail and bracket: 2 1/4"
- Height of rail: 1 1/2"
- Height of bracket: 1 13/16"

Hardware Features	
Standard Hardware	<ul style="list-style-type: none"> • Fabric Wrapped head and bottom rails. Head rail and Bottom rails will have frosted end caps with fabric inserts. • Fabric used to cover the rails is the same fabric as the shade. The back of the rail will be white to the outside.
Simplicity Remote	Upper and lower limit stops pre-programmed, Intermediate stop "favorites" position can be set on site.
Upgrades	
Designer Metallic Upgrade	<ul style="list-style-type: none"> • Smooth faced Designer Oil Rubbed Bronze head, middle, bottom rails and end caps • Smooth faced Designer Brushed Nickel head, middle, bottom rails and end caps

Mounting Dimensions	Simplicity Motorized Hardware System
Minimum Shallow Mount	1/2"
Minimum Flush Inside Mount	2 1/4"
Minimum Outside Mount	7/8"
Minimum Side Mount	1 1/4"
Recommended Side Mounting Method	<ul style="list-style-type: none"> • See page 21 for recommended mounting method for side mount shades • Width limit for side mount brackets is 48"

Finished Dimensions	
Inside Mount	
	<ul style="list-style-type: none"> • Fabric will measure ordered width less: 3/8" • Head rail* will measure ordered width less: 3/16"
Outside Mount	
	<ul style="list-style-type: none"> • Fabric will measure ordered width • Head rail* will measure ordered width plus: 3/16"
Side Mount	
	<ul style="list-style-type: none"> • Fabric will measure ordered width less: 7/8" • Head rail* will measure ordered width less: 1 1/16"
Exact (End Cap to End Cap) Mount	
	<ul style="list-style-type: none"> • Fabric will measure ordered width less: 3/16" • Head rail* will measure ordered width

* Head rail measurements include endcaps. Width and length measurements may vary +/- 1/8"

Color Lux® Cellular Shades

7.4V RECHARGEABLE POWERTOCH MOTORIZED HARDWARE SYSTEM

COLORLUX® CELLULAR SHADES

PowerTouch™ Rechargeable Shades

Cellular Shades can be fabricated with the PowerTouch Rechargeable Push Button Control option. The PowerTouch Rechargeable option is an easy, cord free motorized operation for the budget savvy homeowner. PowerTouch Rechargeable uses Simplicity motors and components.

PowerTouch Rechargeable Shades Operation

Press the up or down button on the pendant to raise or lower the shading to your desired position.

No programming is required with PowerTouch™, all programming is set at the factory. Upper and lower limits easily can be adjusted in the field if desired. Please refer to the installation instructions at comfortex.com/comfortex-dealers. A "favorites" or intermediate stop position can be set once installed.

PowerTouch Rechargeable Surcharges

See page 7.

PowerTouch Appearance

- The PowerTouch wand and pendant is attached to the head rail when installed.
- The wand and pendant hangs down the front of the shades from the head rail. The wand does not touch the fabric.
- Pendant is 2½" long.
- The pendant does not need to be mounted to the wall to operate the shade.



PowerTouch Rechargeable Color Options

- Shades with Black or Oil Rubbed Bronze hardware will be built with black wand and pendants standard. All other colors will use white wand and pendants.



White



Black Shown with Plug-In Charger

PowerTouch Wand and Pendant Location

The standard location for the wand and pendant is on the right. Please specify location when ordering.

PowerTouch Rechargeable Wand Length

- The standard length of the wand will measure the indicated below unless otherwise specified.

Shading Length	Standard Wand Length
Up to 30"	1' (12")
>30" to 52"	2' (24")
>52" to 78"	3' (36")
>78" to 100"	4' (48")
>100" to 120"	5' (60")

Mounting Requirements for PowerTouch Rechargeable Shades

- No special installation hardware or wiring requirements are needed.

Battery Charger

8.4 Volt charger requires a standard power outlet to recharge the battery wand. Must specify charger when ordering a Simplicity Rechargeable Wand Shade. The charger plugs into the charger port. The charger is black and comes with a 156" (13') wire. The dimensions are 1" wide x 2½" length x 1¾" deep.



PowerTouch Rechargeable Shades Warranty

Please see page 154 for complete warranty information.

Color Lux® Cellular Shades

OVATION CELLULAR SLIDER HARDWARE SYSTEM

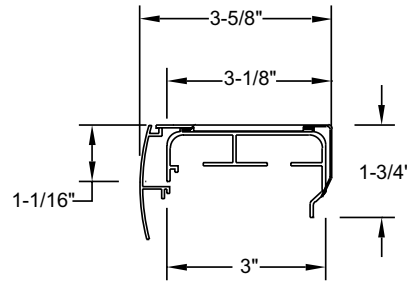

Ovation Hardware Rail Dimensions

- Depth of rail: 3"
- Depth of rail and bracket: 3 1/8"
- Height of rail: 1 3/4"

Hardware Features	
Standard Hardware Color	Aspen White #785
Optional Hardware Colors	Ivory, beige, tan and gray rails are available as an option. Visit comfortex.com to view color options <ul style="list-style-type: none"> • Silverado #276 • Honey Bisque #882 • Camel #082 • Gardenia White #862
Mounting Dimensions	
Ovation Hardware System	
Minimum Inside Mount	3/4"
Minimum Flush Mount	3 5/8"
Minimum Outside Mount	5/8"
Finished Dimensions	
Inside Flush Mount	
Track Width:	
Right or Left Stack	3/16" less than ordered width
Split Stack	3/16" less than ordered width
Center Stack	3/16" less than ordered width
Finished Slider Length	1/2" less than ordered width
Valance	3/16" less than ordered width
Outside Mount	
Track Width	Ordered width
Finished Slider Length	Ordered length - No reductions will be made
Valance	Ordered width plus 1 1/4"
Valance Returns	Will measure 3 1/8" (standard)

Color Lux® Cellular Shades

OVATION CELLULAR SLIDER HARDWARE SYSTEM

COLORLUX® CELLULAR SHADES

Applications

- Standard Rectangular
- Opens and closes from side to side
- Four stacking options - see below.
- Dual Panel option with a center opening design with two fabrics, one on each side, each spanning the width of the window.

Ovation Stacking Options

Specify stacking configuration when ordering.

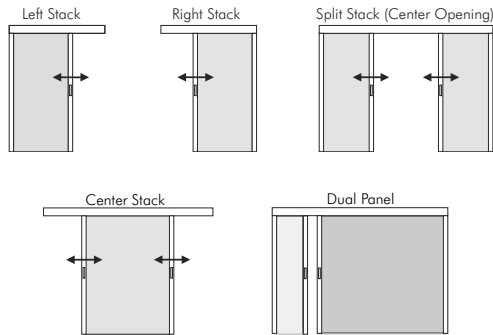

Left: Fabric stacks to the left side of the slider.

Right: Fabric stacks to the right side of the slider.

Center Stack: Center Stack Sliders fabric panels can move fully to the left or the right.

Split Stack: Fabric is split in the center of the slider forming two equal panels which open to opposite ends of the slider. Both panels will be of equal width unless otherwise specified. Split stack is not available with Gradient shades.

* Split stack sliders are available in maximum widths from 240" to 336" (maximum width depends on the fabric selected). If the width exceeds the maximum width of the fabric, it will be fabricated as two separate sliders. The supplied valance will create the appearance of a single slider.

Dual Panel: A Dual Panel Stack Slider has a center opening design with a different fabric on each side, each of which can span the full width of the window. Both panels will be of equal width unless otherwise specified. Specify which fabric stacks to left and which fabric stacks to the right.

Ordering Information for Ovation Cellular Sliders

- Specify IB or OB mount.
- Specify stacking configuration.
 - On Dual Panel Shades, specify which fabric stacks to the left and right.
 - On Split Stack Shades, both panels will be of equal width unless specified.
- Specify valance width and return length.

Ovation Valance Specifications

- Every Ovation Slider is supplied with a painted aluminum valance to match your hardware color choice.
- The valance attaches to the head rail using a durable plastic clip system.

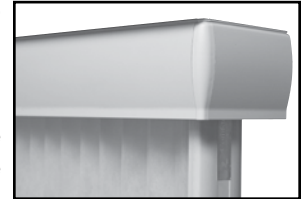

Ovation Valance Dimensions

All valance dimensions are measured on the flat, back side.

- Valance Height: 2¾"
- Standard Return Length (OB only): 3⅛"
- For each spacer block, ½" will be added to the length of the valance returns. For extension brackets, 2" will be added unless otherwise instructed.
- If the slider requires a non-flush inside mount, you must order a custom valance. Exact valance width and exact valance return length (minimum 1½") must be specified in the Special Instructions section of the order form.
- Custom returns are available for IB non-flush and OB Cellular Sliders. Please specify return length upon ordering.

Things to Consider

- Since most Ovations are sold in large sizes, the shade will have a large fabric stack. On an outside mount, you may want to order the shade a few inches wider so that the fabric stack can be clear of the window.
- **Minimum Ovation Stack:** Ovation's minimum fabric stack measures 6½" regardless of the ordered width. Minimum fabric stacking dimensions are determined by the slider's hardware, not ordered width.

Color Lux® Cellular Shades

7.4V RECHARGEABLE SIMPLICITY WAVE MOTORIZED HARDWARE SYSTEM

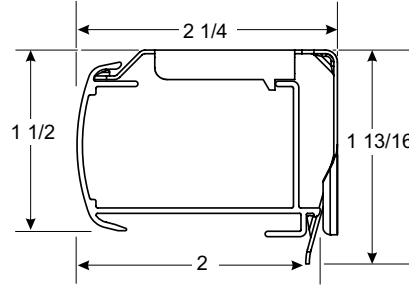

Simplicity Rechargeable Rail Dimensions

- Depth of rail: 2"
- Depth of rail and bracket: 2 1/4"
- Height of rail: 1 1/2"
- Height of bracket: 1 13/16"

Hardware Features	
Standard Hardware	<ul style="list-style-type: none"> • Fabric Wrapped head and bottom rails. Head rail and Bottom rails will have frosted end caps with fabric inserts. • Fabric used to cover the rails is the same fabric as the shade. The back of the rail will be white to the outside.
Telescoping Wand	Extends to 33" to reach shades mounted high. Wand retracts to 9" for easy storage.

Mounting Dimensions	Simplicity Wave Rechargeable Motorization Hardware System
Minimum Shallow Mount	1/2"
Minimum Flush Inside Mount	2 1/4"
Minimum Outside Mount	7/8"
Minimum Side Mount	1 1/4"
Recommended Side Mounting Method	<ul style="list-style-type: none"> • See page 21 for recommended mounting method for side mount shades • Width limit for side mount brackets is 48"

Finished Dimensions	
Inside Mount	
	<ul style="list-style-type: none"> • Fabric will measure ordered width less: 3/8" • Head rail* will measure ordered width less: 3/16"
Outside Mount	
	<ul style="list-style-type: none"> • Fabric will measure ordered width • Head rail* will measure ordered width plus: 3/16"
Side Mount	
	<ul style="list-style-type: none"> • Fabric will measure ordered width less: 7/8" • Head rail* will measure ordered width less: 1 1/16"
Exact (End Cap to End Cap) Mount	
	<ul style="list-style-type: none"> • Fabric will measure ordered width less: 3/16" • Head rail* will measure ordered width

* Head rail measurements include endcaps. Width and length measurements may vary +/- 1/8"

Color Lux® Cellular Shades

7.4V RECHARGEABLE SIMPLICITY WAVE MOTORIZED HARDWARE SYSTEM

COLORLUX® CELLULAR SHADES

Wave Rechargeable Simplicity Motor

The Simplicity Wave Motor features a battery powered motor utilizing a rechargeable battery hidden inside the shade head rail. Simplicity wave motors are compact and use a telescoping wand to raise or lower the shades.

Wave Rechargeable Motorized Lift Systems are not offered on sizes within the shaded area on the Standard Rectangular price grids.

Applications

- Rectangular

EZ Level

Learn about the EZ Level feature on page 62.

Simplicity Wave Rechargeable Motorization Surcharges

The Simplicity Wave Rechargeable Motorized Lift System surcharge includes a rechargeable battery. A Wand is needed to operate the shades and a charger to charge the battery. Refer to pricing pages.

Ordering Information for Rechargeable Motorized Cellular Shades

Simplicity Motor Option

- Specify IB or OB mount and rail color.
- Specify wand and other accessories if needed.
- Specify one or more battery chargers.

Please Note:

- Not all motors run at the same rate of speed.
- Simplicity Wave Rechargeable Motorized Cellular Shades are programmed at the factory with the "up and down" limits.
- Favorites position can be set on site.
- **REMEMBER: Order at least one charger if ordering rechargeable motors.**

SIMPLICITY RECHARGEABLE BATTERY WAND PRICING EXAMPLE:	
Linen Weave	
Light Filtering 42" x 60" Shade:	\$422.00
Simplicity Wave Surcharge:	\$132.00
Charger for Wave Rechargeable:	\$30.00
Simplicity Wave Wand:	\$30.00
Total List Price:	\$614.00

Simplicity Wave Rechargeable Battery

The rechargeable battery is concealed in the head rail of the shade. A charger is required for the rechargeable battery. The rechargeable battery comes fully charged from the factory.

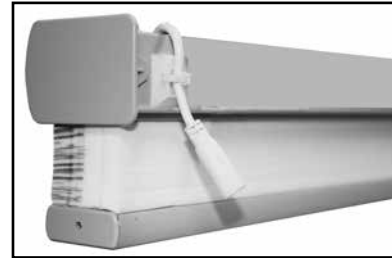

Charging Port on Back of Head rail.

Simplicity Rechargeable Battery Life

Rechargeable batteries are included with the motor.

The average battery charge will last 6-12 months based on an average sized shade raised and lowered once per day. The life of the battery charge will vary based on the type of window covering selected, the size and weight of the window covering and the number of times the shade is operated on a daily basis.

The battery can be recharged up to 500 times. It takes approximately 5 hours to recharge the motor when fully depleted.

Battery Charger

8.4 Volt charger requires a standard power outlet to recharge the battery pack. Must specify charger when ordering a Simplicity Rechargeable Wand Shade. The charger plugs into the charger port. The charger is black and comes with a 156" (13') wire. The dimensions are 1" wide x 2½" length x 1¾" deep.



Telescoping Wand

- Extends to 33" to reach shades mounted high.
- Wand retracts to 9" for easy storage.
- The wand is silver with white handle and white magic tip.
- Wall mount plate included for convenience.
- Wand is universal and will operate all Simplicity Wave shades



Simplicity Motorized Shade Warranty

Please see page 154 for complete Comfortex warranty information.

The Ultimate Blackout Color Lux® Cellular Shade

INSULATING SLUMBERSHADES HARDWARE SYSTEM



Deluxe Head Rail

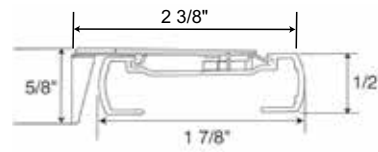

Cord Loop & Cordless Ultra Head Rail (Standard & Top Down-Bottom Up)

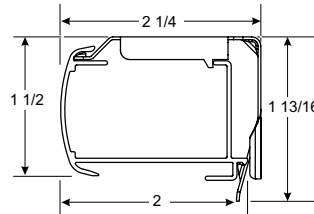

Deluxe Cord Lock Rail

- Depth of rail: 1 7/8"
- Depth of rail and bracket: 2 3/8"
- Height: 1/2"
- Height of bracket: 5/8"

Cord Loop & Cordless Ultra Rail

- Depth of rail: 2"
- Depth of rail and bracket: 2 1/4"
- Height of rail: 1 1/2"
- Height of bracket: 1 13/16"

Hardware Features	
Hardware colors for all Cellular fabrics	Fabric wrapped head, middle, bottom rails and end caps is standard. Back of rail is white to outside.
Blackout Sidetrack Colors Available	White, Tan and Bronze
Upgrades	
Designer Metallic Upgrade	• Oil Rubbed Bronze and Brushed Nickel head, middle, bottom rails and end caps.
Mounting Dimensions (inside mount only)	
Deluxe Head Rail	
Standard Cord Lock (Standard Rectangular and Top Down-Bottom Up)	
Minimum Inside Mount	1 1/2"
Minimum Flush Inside Mount	2 3/8"
Cord Loop & Cordless Ultra (Standard Rectangular and Top Down-Bottom Up)	
Minimum Inside Mount	1 1/2"
Minimum Flush Inside Mount	2 3/8"
Outside, shallow and side mounts are not available. The shade's light blocking ability is compromised by using any other mount than a fully flush mount application.	
Finished Dimensions	
Inside Mount	
	<ul style="list-style-type: none"> • Fabric will measure ordered width less: 7/8" • Head rail and bottom rail will measure ordered width less: 1 1/16" • Sidetrack length will measure ordered length less: 1/8"

The widest width of the window cannot exceed the narrowest width of the window by more than 1/4".

Precise width measurements are critical to proper performance of SlumberShade products. Make sure to measure to the nearest 1/16" and provide the NARROWEST width measurement along the length of the window. Be sure to measure the top, middle and bottom of the opening. It is very common for the width of a window to vary from top to bottom.

The Ultimate Blackout Color Lux® Cellular Shade

INSULATING SLUMBERSHADES HARDWARE SYSTEM

COLORLUX® CELLULAR SHADES

Applications

- Standard Rectangular • Top Down - Bottom Up
- Cordless and Cordless Top Down - Bottom Up
- Cord Loop and Top Down - Bottom Up
- Motorization

SlumberShades are for inside mount applications only.

Insulating SlumberShade Fabric

Light Filtering fabrics are available as SlumberShades, however the best light control is achieved by using a blackout cellular fabric. Not available in Boutique fabric.

Ordering Information for Insulating SlumberShades

SlumberShades are for inside mount applications only.

Precise width measurements are critical to proper performance of SlumberShade products. Make sure to measure to the nearest 1/16" and provide the **NARROWEST** width measurement along the length of the window. Be sure to measure the top, middle and bottom of the opening. It is very common for the width of a window to vary from top to bottom. The widest width of the window cannot exceed the narrowest width of the window by more than 1/4".

If you have questions about ordering SlumberShades, contact Comfortex Technical Services at 800-843-4151.

Accessories

- 6' Expandable Pole:
- 12' Expandable Pole:

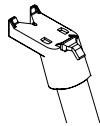

Specially designed pole end fits into the handle on the Cordless Ultra bottom rail and allows for easy operation.

Insulating SlumberShades Features

Use SlumberShades to provide the darkest sleeping environment by sealing out the highest percentage of light.

Energy Saving Blackout Sidetracks

Energy saving blackout sidetracks are made from a durable window grade PVC. The blackout sidetracks seal off the light gap between the blackout cellular shade and the window. The blackout sidetracks feature a black interior lining to absorb light and prevent it from entering the room.



Insulating SlumberShades Large Track Dimensions Used with all fabrics that utilize the deluxe sized head rail.

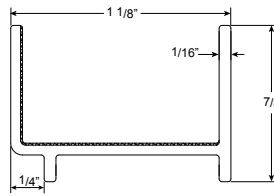

Large Track

- Width of track: 1 1/8"
- Height of track: 7/8"

SlumberShades are easy to install, and feature removable sidetracks that are attached to the window frame with magnets. The sidetracks can be removed for window cleaning. The UV stable, window grade PVC sidetracks are available in white, tan and bronze to match your existing trim.

Please Note: When properly installed, SlumberShades block 99% of all visible light. In certain installations with intense sunlight, a very small amount of light may reflect around the edges of the honeycomb fabric along each side of the shade. This is a normal attribute of the SlumberShade system.

Insulating SlumberShade End Caps

The specially designed notched bottom rail end caps fit over the blackout sidetracks and allow for smooth movement when raising and lowering the shade.

Head and Bottom Rail Seals

To ensure a perfectly dark sleeping environment, additional fuz bar are supplied to be placed along the shade's bottom rail and between the head rail and the window frame if needed. These barriers provide a complete light stop all the way around the window to keep all exterior light out. Also, these additional seals provide a very effective barrier against heat loss along your windows.

Magnets and fuzz bar are standard on Cordless and Cordless Top Down-Bottom Up Shades to ensure closure between the bottom rail and window sill.

Energy Efficiency

Independent testing has shown SlumberShades provide an R-value greater than 7.0* when installed over a double paned vinyl window. The testing also indicates that the R-value of a SlumberShade is 2.5 to 3 times higher than that of the same shade without sidetracks. The insulating cellular fabric, sidetracks, and fuz bar all ensure that the SlumberShades provides superior energy efficiency.

* Independent testing provided by Consortium for Advanced Residential Buildings (CARB), a U.S. Department of Energy Building America research team. Learn more at comfortex.com.

EZ Level

Learn about the EZ Level feature on page 62.

Color Lux® Cellular Shades
STRATAVIEW™ HARDWARE SYSTEM

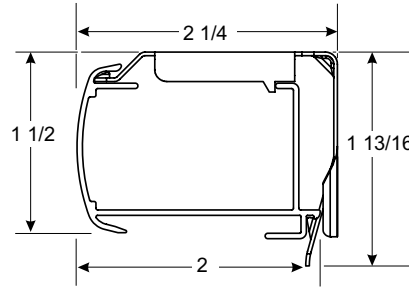

Cord Loop, Cordless Ultra & Simplicity Rechargeable Rail Dimensions

- Depth of rail: 2"
- Depth of rail and bracket: 2 1/4"
- Height of rail: 1 1/2"
- Height of bracket: 1 13/16"

Your choice of Color Lux fabrics as the top and bottom panels.
 Aspen fabric not available with Strataview.

Hardware Features	
Fabric Wrapped	Fabric wrapped head rail to match color of top fabric/sheer or bottom fabric, middle and bottom fabric wrapped rails will match bottom fabric selection. Back of rail is white to outside. Frosted clear with fabric insert end caps. Clutch cover and Cordloop is white on cordloop shades.
Designer Metallic	<ul style="list-style-type: none"> • Oil Rubbed Bronze head and bottom rails with bronze end caps and white cord. • Brushed Nickel head and bottom rails and end caps with white cord.
Mounting Dimensions	
Minimum Shallow Mount	1/2"
Minimum Flush Inside Mount	2 1/4"
Minimum Outside Mount	7/8"
Minimum Side Mount	1 1/4"
Recommended Side Mounting Method	<ul style="list-style-type: none"> • See figure A, page 21 for recommended mounting method for side mount shades • Width limit for side mount brackets is 48"
Finished Dimensions	
Inside Mount	
	<ul style="list-style-type: none"> • Fabric will measure ordered width less: 3/8" • Head rail* will measure ordered width less: 3/16"
Outside Mount	
	<ul style="list-style-type: none"> • Fabric will measure ordered width • Head rail* will measure ordered width plus: 3/16"
Side Mount	
	<ul style="list-style-type: none"> • Fabric will measure ordered width less: 7/8" • Head rail* will measure ordered width less: 1 1/16"
Exact (End Cap to End Cap) Mount	
	<ul style="list-style-type: none"> • Fabric will measure ordered width less: 3/16" • Head rail* will measure ordered width
* Head rail measurements include endcaps. Width and length measurements may vary +/- 1/8"	



Top Panel and Bottom Panel



Bottom Panel Raised



Top Panel Lowered

Color Lux® Cellular Shades

STRATAVIEW™ HARDWARE SYSTEM

COLORLUX® CELLULAR SHADES

StrataView™

StrataView is a dual panel shade featuring your choice of either a sheer or ColorLux fabric panel and Color Lux fabric as the second panel.

Hardware Options

- Cord Loop
- Cordless Ultra
- TDBU Simplicity Rechargeable Motorization

Cord Loop Hardware System

See page 18 for details.

Cordless Ultra Hardware System

See page 22 for details.

Simplicity Rechargeable Motorized Hardware System

See page 28 for details.

Recommended Mounting Method for Side Mounting Shades

See Page 21.

EZ Level on Cellular Shades

EZ Level makes quick work of leveling without cords to cut or tuck into a rail. Middle rail can not be adjusted in the field. See page 62 for details.

StrataView Fabric Specifications

Sheer fabric is available on the top of the shade. See fabric samples of the 3 sheer fabrics for the top of the StrataView in the Color Lux Sample Book.

BOTTOM FABRICS

CELLULAR	Width		Length	
	Min	Max	Min	Max
Cordless	18" OB 18 3/8" IB	96"	8"	84"
Cordloop	22"	108"	8"	120"
Motorized	24" OB 24 3/8" IB	108"	8"	120"

Motorized StrataView Shades less than 36" in width require an external mounted battery. See page 32

MOTORIZED STRATAVIEW TOP DOWN-BOTTOM UP PRICING EXAMPLE:

Linen Weave	
Light Filtering 42" x 60" Shade:	\$422.00
Simplicity Rechargeable Surcharge:	\$786.00
Charger for Rechargeable:	\$30.00
TDBU Remote Control:	\$72.00
Total List Price:	\$1310.00

Ordering Information for StrataView Shades

Cord Loop StrataView

- Specify IB or OB mount and rail color.
- Middle and bottom rail will match the bottom fabric. Top rail can match top or bottom fabric, your choice.
- Specify cord loop length when ordering.
- Controls are the right cord loop operates the middle rail and left cord loop operates the bottom. Reverse controls are not available.

Cordless Ultra StrataView

- Specify IB or OB mount and rail color.
- Middle and bottom rail will match the bottom fabric. Top rail can match top or bottom fabric, your choice.

Accessories

- 6' Expandable Pole:
- 12' Expandable Pole:

Specially designed pole end fits into the handle on the Cordless Ultra bottom rails and allows for easy operation.

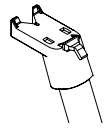

Simplicity Rechargeable StrataView

- Specify IB or OB mount and rail color.
- Middle and bottom rail will match the bottom fabric. Top rail can match top or bottom fabric, your choice.
- Specify remote and other accessories if needed.
- Specify one or more battery chargers.

StrataView Simplicity Motor Hand Held Remote 14 Channel Remote

The TDBU remote has 14-channels. Each channel has a setting to operate the middle rail and a setting to operate the bottom rail. The TDBU remote is required for StrataView motors. The **14 Channel TDBU remote** can operate up to fourteen shades individually or 14 groups. Simplicity Rechargeable Motorized Cellular Shades are programmed at the factory with the "up and down" limits. The shades are **UNLINKED** from the remote so they are not able to operate during shipping. Each shade should be installed **after** linking it to the remote.



Simplicity TDBU remotes and holders are white in color. The remote comes with a holder which can be mounted to a wall for easy storage. The range of the remote is approximately 80 feet.

REMEMBER: Order at least one charger if ordering rechargeable motor

Recommended Mounting Method for Side Mounting Shades

See Page 21.

Color Lux® Cellular Specialty Shades

STARBURST ARCHES HARDWARE SYSTEM

Stationary Starburst

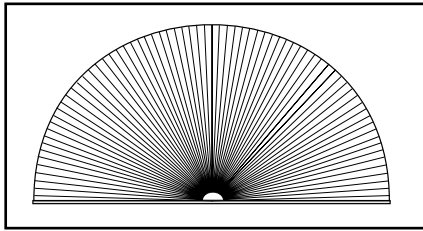

Figure A

Movable Starburst

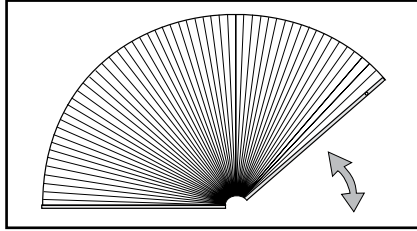

Figure B

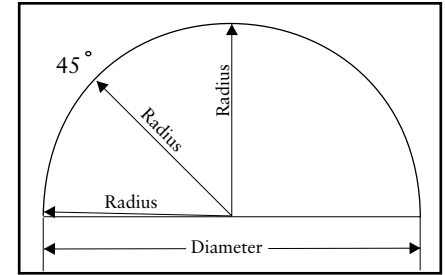

Figure C

Hardware Features | See Page 18 for Rail Dimensions

Standard Hardware	Fabric wrapped rail is standard. The fabric will be spliced in the center of the rail. A decorative rosette is supplied to conceal the splice.
Designer Metallic	<ul style="list-style-type: none"> • Oil Rubbed Bronze rails with bronze colored end caps. • Brushed Nickel rails and end caps.

Mounting Dimensions

Mounting Dimensions	Standard Cord Lock Rail
Minimum Shallow Mount	3/4"
Minimum Flush Inside Mount	2 3/8"
Recommended Side Mounting Method	<ul style="list-style-type: none"> • See figure A, pg 21 for recommended mounting method for side mount shades • Width limit for side mount brackets is 48"

Finished Dimensions

Inside and Side Mount

- Fabric will measure ordered width less: 3/8"
- Head rail* will measure ordered width less: 3/16"
- * Head rail measurements include endcaps. Width and length measurements may vary +/- 1/8"

Applications

- Stationary Fan Style Arch
 - Movable Fan Style Arch
- Movable Starburst Arch shades are for inside and shallow mount applications only.

Stationary Starburst Features (Figure A)

- **All non-perfect Stationary Starburst arches require a template made from brown craft paper.** Comfortex offers template kits. Please contact Customer Service to order. Stock number: 751000, See page 151
- A perfect arch is twice as wide as it is high.
- Stationary Starburst shades which are not perfect half circles must have a height that equals half the width +/- 5".
- Price according to the largest radius measurement. If the height is greater than the width, take height X 2 and use that number to determine pricing.
- When ordering arches as perfect half-circles make sure the radius of the arch remains constant to ensure a proper fit. (See Figure C)

Movable Starburst Features (Figure B)

- Starburst Movable archtop shades are cut to perfect half circles only and do not require a template. The height must be exactly 1/2 the diameter.
- A perfect arch is twice as wide as it is high.
- When ordering arches as perfect half circles make sure the radius of the arch remains constant to ensure a proper fit. (See Figure C)
- The hinge gap (gap between the two rails) is not centered in the window. The moving rail is always smaller than the stationary rail to provide proper movement within the window.

Accessories

- 6' Expandable Pole:
- 12' Expandable Pole:

Specially designed pole end fits into the handle on movable Starburst Shades for easy operation.



Color Lux® Cellular Specialty Shades

QUARTER ROUNDS HARDWARE SYSTEM

COLORLUX® CELLULAR SHADES

Movable Quarter Round

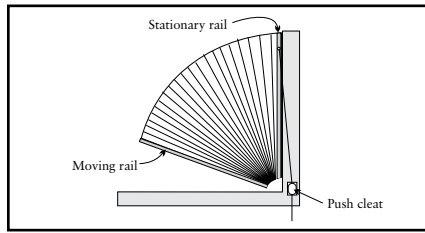

Figure A

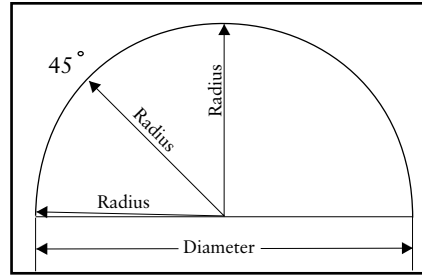

Figure B

Stationary Quarter Round

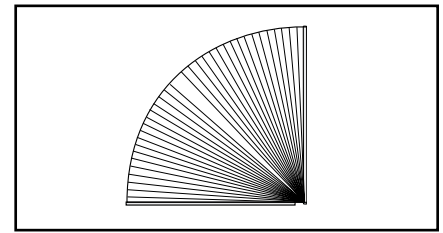

Figure C

Hardware Features | See Page 18 for Rail Dimensions

Hardware colors for all Cellular and Pleated fabrics | Fabric wrapped rails with white cord and tassel. Fabric used is same fabric as the shade. Back of rail is white to outside.

Upgrades

- Designer Metallic Upgrade
 - Oil Rubbed Bronze rails and endcaps, bronze colored tassel and white cord.
 - Brushed Nickel rails and end caps with coordinating tassel and white cord.

Mounting Dimensions

Mounting Dimensions	Standard Rail	Deluxe Rail
Minimum Shallow Mount	3/4"	3/4"
Minimum Flush Inside Mount	2"	2 3/8"
Minimum Outside Mount	3/4"	3/4"
Minimum Side Mount	1 1/8"	1 3/8"
Recommended Side Mounting Method	• See page 21 figure A for recommended mounting method for side mount shades	

Finished Dimensions

Inside and Side Mount

- Fabric will measure ordered width less: 3/8"
- Head rail* will measure ordered width less: 3/16"

Outside Mount

- Fabric will measure ordered width
- Head rail* will measure ordered width plus: 3/16"

Exact (End Cap to End Cap) Mount

- Fabric will measure ordered width less: 3/16"
- Head rail* will measure ordered width

* Head rail measurements include endcaps.
Width and length measurements may vary +/- 1/8"

Applications

- Stationary Fan Style Quarter Round
- Movable Fan Style Quarter Round

Accessories

- 6' Expandable Pole:
- 12' Expandable Pole:



Specially designed pole end fits into the handle on movable Quarter Round Shades for easy operation.

Ordering Information for Quarter Rounds Shades

- Specify IB or OB mount and rail color.
- Include a template if the shade is a non-perfect quarter round.

Color Lux® Cellular Specialty Shades

QUARTER ROUNDS HARDWARE SYSTEM

Quarter Rounds Features (Figure B, page 47)

- **All Quarter Round Shades which are not perfect quarter circles require a template.** Price according to the largest radius measurement.
- See page 151 for template instructions.
- **All templates should be made from brown craft paper.** Comfortex offers template kits. Please contact Customer Service to order. Stock number: 751000
- The horizontal (moving) rail of a Movable Quarter Round shade **must be smaller** than the vertical (stationary) rail to allow clearance for the moving rail. The shade will stack in the vertical position.
- When ordering arches as perfect quarter circles, make sure the radius of the arch remains constant to ensure a proper fit. (See Figure B, page 47)



Color Lux® Cellular Specialty Shades
SUNSET ARCHES HARDWARE SYSTEM

COLORLUX® CELLULAR SHADES

Movable Sunset

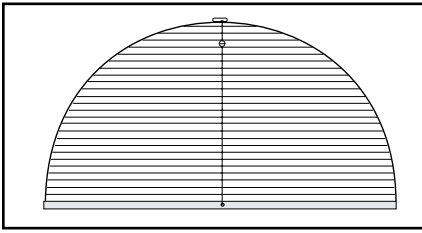

Figure A

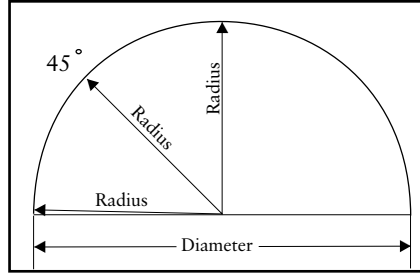

Figure B

Two-String Hanging Method

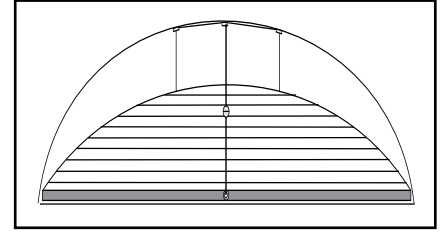

Figure C

Hardware Features | See Page 18 for Rail Dimensions

Fabric Wrapped	Fabric used is same fabric as the shade. Back of rail is white to outside. Clear frosted end caps, white cord and silver tassel
Designer Metallic	<ul style="list-style-type: none"> • Oil Rubbed Bronze rails with bronze colored end caps and white cord. • Brushed Nickel rails and end caps with white cord.

Mounting Dimensions

Standard Cord Lock Rail

Minimum Shallow Mount	3/4"
Minimum Flush Inside Mount	2 3/8"
Minimum Outside Mount	3/4" Outside mounting requires the use of an extension "L" bracket for the mounting of the top block.
Minimum Side Mount	1 1/8"
Recommended Side Mounting Method	<ul style="list-style-type: none"> • See page 21, figure A for recommended mounting method for side mount shades • Width limit for side mount brackets is 48"

Finished Dimensions

Inside and Side Mount

- Fabric will measure ordered width less: 3/8"
- Head rail* will measure ordered width less: 3/16"

Outside Mount

- Fabric will measure ordered width
- Head rail* will measure ordered width plus: 3/16"

Exact (End Cap to End Cap) Mount

- Fabric will measure ordered width less: 3/16"
- Head rail* will measure ordered width

* Head rail measurements include endcaps.
 Width and length measurements may vary +/- 1/8"

Applications

- Movable Arch

Ordering Information for Sunset Shades

- Specify IB or OB mount and rail color.
- Include a template if the shade is a non-perfect arch.

Accessories

- 6' Expandable Pole:
- 12' Expandable Pole:



Specially designed pole end fits into the ball on Sunset Shades for easy operation.

Color Lux® Cellular Specialty Shades

SUNSET ARCHES HARDWARE SYSTEM

Sunset Features and Ordering Notes

(Figure A, pg 49)

- Sunset shades have horizontal pleats that stack at the bottom, on a stationary sill rail. Sunset shades are operated by a continuous cord that runs through a top mount guide block and back down through the stationary rail. A moving metal ball attached to the cord is used to raise and lower the shade. (See Figure E).
- **All Sunset arches which are not perfect half circles require a template.** A perfect arch is twice as wide as it is high. See page 151 for template instructions.
- **All templates should be made from brown craft paper.** Comfortex offers template kits. Please contact Customer Service to order. Stock number: 751000
- Sunset shades which are not perfect half circles must have a height which is equal to or greater than 25% of the width.
- When ordering Sunset shades that are perfect half circles, make sure the radius of the arch remains constant to ensure a proper fit. (See Figure B).
- **Stringing Method:** Depending on the curvature of a particular arch, it may be necessary to use the two string method (See Figure C) to ensure proper fit and operation of your Sunset shade. Comfortex will determine the best stringing method after examination of the template.
- **Arch Styles:** Sunset arches are available in a variety of styles including: palladium, eyebrow and bullet shaped arches. (See Figure D).

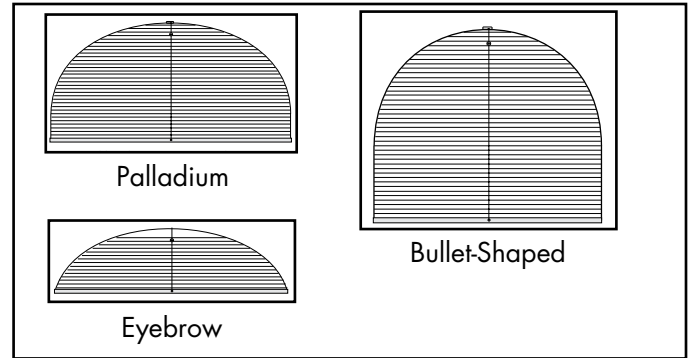

Figure D

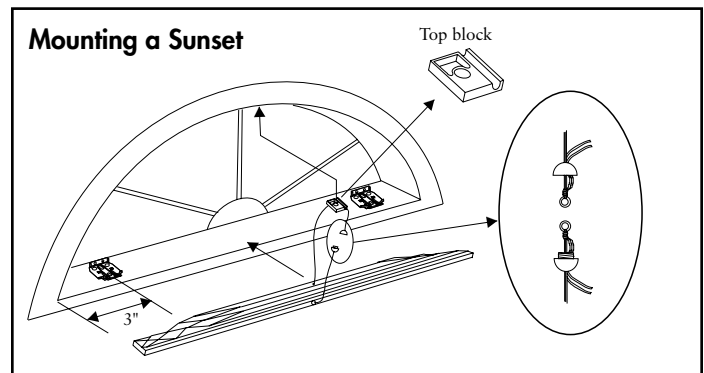

Figure E

Recommended Mounting Method for Side Mounting Shades

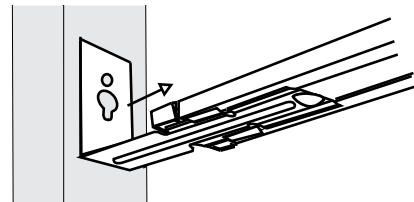

Figure F

Refer to the installation instructions on Comfortex.com or the OnDemand Mobile Library for further details on side mounting shades.

Color Lux® Cellular Specialty Shades

TRAPEZOIDS AND OCTAGONS HARDWARE SYSTEM

COLORLUX® CELLULAR SHADES

Movable Trapezoids

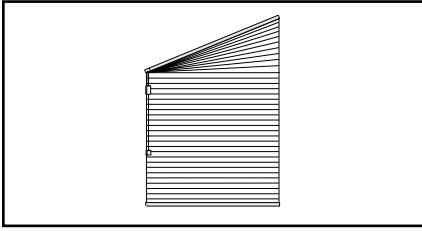

Movable Octagons

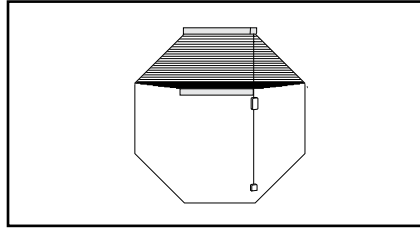

Hardware Features | See Page 18 for Rail Dimensions

Fabric Wrapped	Fabric used is same fabric as the shade. Back of rail is white to outside. Frosted clear end caps with white cord and tassel
Designer Metallic	<ul style="list-style-type: none"> • Oil Rubbed Bronze head and bottom rails with bronze colored tassel, end caps and white cord. • Brushed Nickel head and bottom rails and end caps with coordinating tassel and white cord.

Mounting Dimensions

Standard Cord Lock Rail

Minimum Shallow Mount	3/4"
Minimum Flush Inside Mount	2"
Minimum Outside Mount	3/4"
Minimum Side Mount	1 1/8"
Recommended Side Mounting Method	<ul style="list-style-type: none"> • See page 21 for recommended mounting method for side mount shades • Width limit for side mount brackets is 48"

Finished Dimensions

Inside and Side Mount

- Fabric will measure ordered width less: 3/8"
- Head rail* will measure ordered width less: 3/16"

Outside Mount

- Fabric will measure ordered width
- Head rail* will measure ordered width plus: 3/16"

Exact (End Cap to End Cap) Mount

- Fabric will measure ordered width less: 3/16"
- Head rail* will measure ordered width

* Head rail measurements include endcaps.
Width and length measurements may vary +/- 1/8"

Applications

- Movable Trapezoids
- Movable Octagons

Ordering Information for Trapezoid Shades

- Specify IB or OB mount and rail color.
- **Trapezoid orders must be faxed or emailed in with a diagram. Please provide measurements for all four sides when ordering. No template is required.**

Ordering Information for Octagon Shades

- Specify IB or OB mount and rail color.
- **The width, length and one side are required measurements when ordering.**

Color Lux® Cellular Specialty Shades

TRAPEZOIDS AND OCTAGONS HARDWARE SYSTEM

Trapezoids (Figure A)

- Trapezoid orders must be faxed in with a diagram. Please provide measurements for all four sides when ordering. No template is required.
- The maximum slope of the top rail is 30 degrees from horizontal. Slope is the angle between slope and a horizontal line. The slope angle must be measured with a protractor.
- Sides of trapezoid must be parallel.
- Sill must be level for proper installation and operation of a trapezoid shade.
- Operating cord must be placed on the short side.
- See Figures B and C for trapezoid shade operation.

Octagons

- The width, length and one side are required measurements when ordering.
- Octagon shades raise only to the point where the top angle begins. (See Figure D)
- See Figure A on page 21 for recommend mounting method for side mount shades.
- Width limit for side mount brackets is 48".

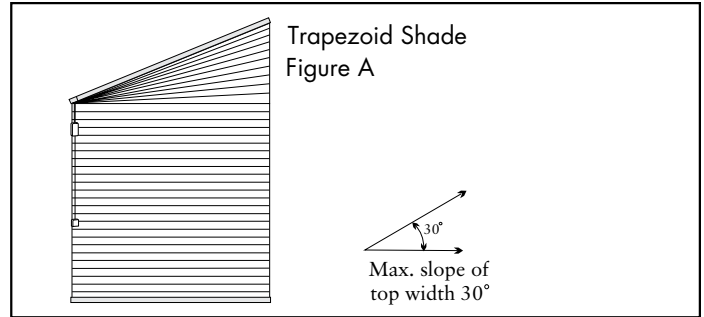

Trapezoid Shade Operation

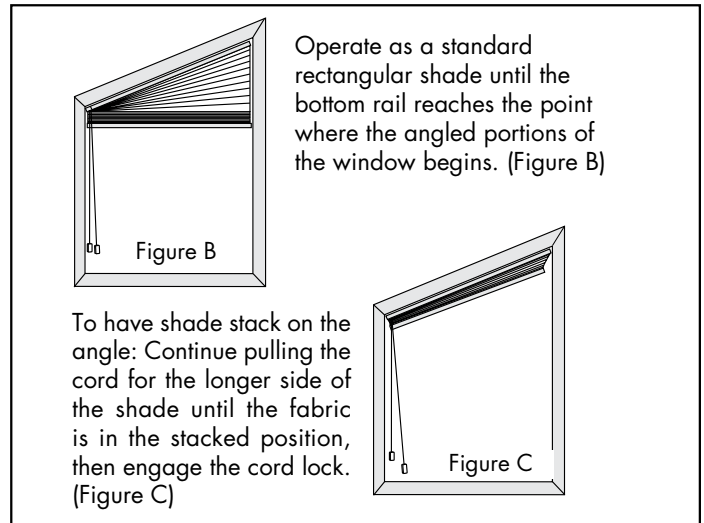

Octagon Operation

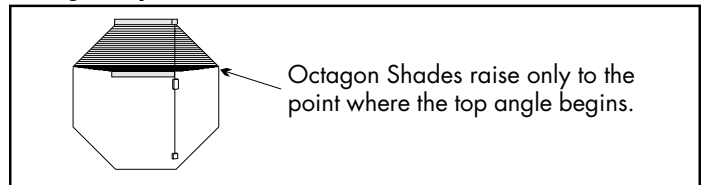
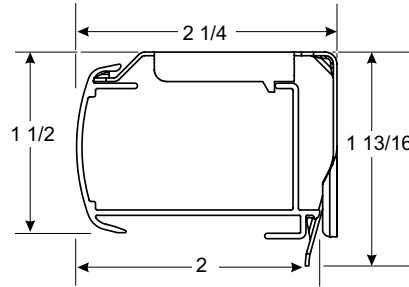

Figure D



Color Lux® Cellular Specialty Shades
MEZZO MOTORIZED SKYLIGHT HARDWARE SYSTEM

COLORLUX® CELLULAR SHADES



Simplicity Motorized Rail Dimensions

- Depth of rail: 2"
- Depth of rail and bracket: 2 1/4"
- Height of rail: 1 1/2"
- Height of bracket: 1 13/16"

Hardware Features

Hardware colors	White head, bottom and side rails
Simplicity Remotes	Upper and lower limit stops pre-programmed, Intermediate stop "favorites" position can be set on site, 5 channel, 6 channel timer or 14 channel option

Mounting Dimensions

Mounting Dimensions	Mezzo Motorized Skylight Shades
Minimum Flush Inside Mount	2 1/2"
	<ul style="list-style-type: none"> • Should not be more than 1/2" out of square to perform as intended • The widest width of the window cannot exceed the narrowest width of the window by more than 3/8". • The shade must be mounted with the fabric stack at the bottom or the lowest point of the window
	See page 54 for Solar Panel information.

Finished Dimensions

Inside Mount	
	<ul style="list-style-type: none"> • Fabric will measure ordered width less: 1 1/4" • Head rail* will measure ordered width less: 3/16"

* Head rail measurements include endcaps. Width and length measurements may vary +/- 1/8"

MOTORIZATION - HARDWARE UPGRADE SURCHARGES AND ACCESSORIES All standard discounts apply to motorized shades		ADD
	Simplicity - Motor and Rechargeable Battery Pack	\$368
	Simplicity 5 Channel Remote	\$44
	Simplicity 6 Channel Remote with Timer	\$72
	Simplicity 14 Channel White Remote	\$72
	48" Extension Wire:	\$20
	Simplicity Smart Controller (NEO)	\$363
	Solar Panel with brackets	\$110
	Plug In Charger: for rechargeable battery pack	\$30

Ordering Information for Mezzo Motorized Skylight Shades

- Specify inside mount dimensions.
- Specify fabric color and style.
- Specify remote and other accessories if needed.

Color Lux® Cellular Specialty Shades

MEZZO MOTORIZED SKYLIGHT HARDWARE SYSTEM

Applications

- Horizontal, Angled and Vertical motorized skylight shades.

Mezzo Motorized Skylight Shades are for inside mount applications only.

Mezzo Power Options

- Simplicity Rechargeable Motor

RECHARGEABLE SIMPLICITY MOTORS

The Simplicity Motor program features a battery powered motor utilizing a rechargeable battery hidden inside the shade head rail. Simplicity motors are compact and use a radio frequency remote to raise or lower the shades.

Simplicity Rechargeable Battery

The rechargeable battery is concealed in the head rail of the shade. A charger is required for the rechargeable battery. The rechargeable battery comes fully charged from the factory.

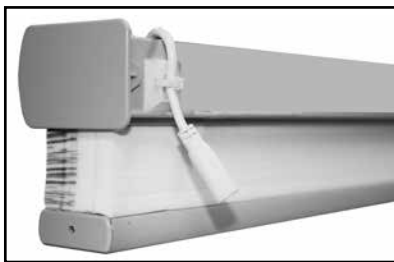

Charging Port on Back of Head rail.

Simplicity Hand Held Remotes

The **5 Channel (5C) remote** can operate up to five shades individually or 5 groups. Simplicity Rechargeable Motorized Cellular Shades are programmed at the factory with the “up and down” limits. The shades are **UNLINKED** from the remote so they are not able to operate during shipping. Each shade should be installed **after** linking it to the remote.



Simplicity 5C remotes and holders are white or black in color. The remote comes with a holder which can be mounted to a wall for easy storage. The range of the remote is approximately 80 feet.

A **6 Channel (6C) timer remote** is also available. See page 31 for more information

The Simplicity remote utilizes one 3V battery (CR2032). Batteries are included. Comfortex will warranty batteries for up to 3 months from date of purchase. Batteries are not covered by the warranty.

A **14 Channel (14C) remote** is also available. This remote is required for TDBU motorization but can be utilized on all Simplicity motorized shades. See page 32 for more information.

Solar Panel Recharge Option

Plugs in to any Simplicity Rechargeable Remote control shade (does not work with PowerTouch)

Provides constant trickle charge to 7.4v Li-Ion Rechargeable battery packs. Does not require direct sunlight, but performs best in regular direct sunlight applications. Will prolong the life of the charge of the 7.4v rechargeable battery packs, and in some applications will maintain charge indefinitely.

Life of charge is subject to application variables such as, size and weight of shade, frequency of use, amount of direct sunlight exposure, etc.



Dimensions of panel
18½" x 1½"

Solar Recharge Optimum Application

- Full direct sunlight (minimum 4-6 hours per day) to maintain full charge. Based on one operation cycle per day (one open, one close).
- Solar panel will charge batteries even without direct sunlight. Ambient light will charge the batteries but at a slower rate.
- Excessive duration of cloudy weather will impact the rate of charge.

Battery Charger

8.4 Volt charger requires a standard power outlet to recharge the battery wand. Must specify charger when ordering a Simplicity Rechargeable Wand Shade. The charger plugs into the charger port. The charger is black and comes with a 156" (13') wire. The dimensions are 1" wide x 2½" length x 1¾" deep.



Color Lux® Cellular Specialty Shades

MEZZO MOTORIZED SKYLIGHT HARDWARE SYSTEM

COLORLUX® CELLULAR SHADES

Solar Panel Location Requirements

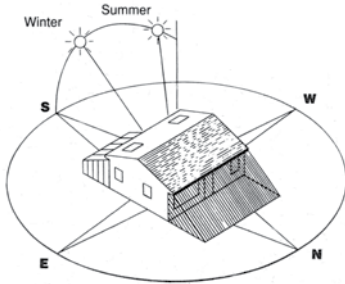

For Locations North of Washington, DC (39° Latitude)





For Locations South of Washington, DC (39° Latitude)



- Assumptions:** 1) Window area free from shadows 9 AM to 3 PM.
2) Glazing is double pane, clear.

Excessive shading or tinted glass will impact the solar charging capability of the system.

-  Indicates orientations which may require periodic manual recharge with Plug In Charger.
-  Indicates orientations which are optimum for solar recharge (wireless systems).

Important Simplicity Motorized Shades Operating and Installation Information

- Simplicity Motorized Shades installed into windows with metal casings may have a reduced radio frequency range, or may not operate at all, depending on the application.
- Do not let the antenna on the motor touch any metal objects. This may interfere with signals from the remote control.
- Make sure to leave the top of the shade head rail open (motor exposed), do not cover; especially with metal materials. This could result in a reduced radio frequency range for the remote control or the shade may not operate at all, depending on the application.



Cellular Specialty Shades

SOPRANO SKYLIGHT HARDWARE SYSTEM

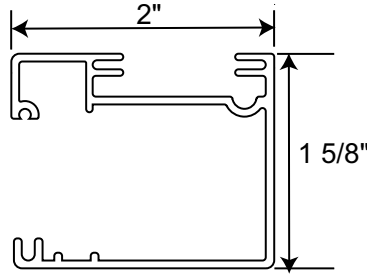

Soprano Rail Dimensions

- Depth of rail: 2"
- Height of rail: 1 5/8"

Hardware Features	
Hardware colors	<ul style="list-style-type: none"> • White head, bottom rail with white gear track retainer. • Bronze head, bottom rail with bronze gear track retainer.
Mounting Dimensions	Soprano Skylights Shades
Minimum depth required for installation	1 1/2"
Minimum Flush Inside Mount (Rail Fully Recessed)	2 3/8"
Minimum Flush Inside Mount (Handle Fully Recessed)	3"
Deductions	
	Total deduction on the bottom moving rail is 3/4"
	Total deduction on the top rail is 1 1/2"
Finished Dimensions	
Inside Mount	
	<ul style="list-style-type: none"> • Fabric will measure ordered width less: 3/8" • Head rail* will measure ordered width less: 3/16"
* Head rail measurements include endcaps. Width and length measurements may vary +/- 1/8"	

Applications

- Soprano Skylights
- Soprano Shades are for inside mount applications only.

Ordering Information for Soprano Skylights Shades

- Specify White or Bronze Rails.

Accessories

- Two Moving Rails*
- 6' Expandable Pole
- 12' Expandable Pole

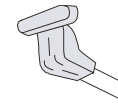

Specially designed pole end fits into the handle of Soprano shades for easy operation at any angle.

*This option allows you to move shade up from the bottom or down from the top. For ultimate control of light and privacy. See page 10 for upgrade pricing.

Skylight Installation Angles

- For inside mount applications on straight (planar) runs.
- Minimum Installation angle of 5 degrees.
- Maximum installation angle of 85 degrees.
- Horizontal (0 degrees) and vertical (90 degrees) applications are not recommended.

Cellular Specialty Shades

SOPRANO SKYLIGHTS AND GREENHOUSE SHADES HARDWARE SYSTEM

COLORLUX® CELLULAR SHADES

Soprano Skylight Features (Figure A)

- Soprano Shades feature a polycarbonate track system. The hidden gear track allows for smooth operation of the shade and controls light.
- The gear track retainer is White or Bronze to match the moving bottom rail. **Please specify rail color when ordering.**

Soprano Skylights

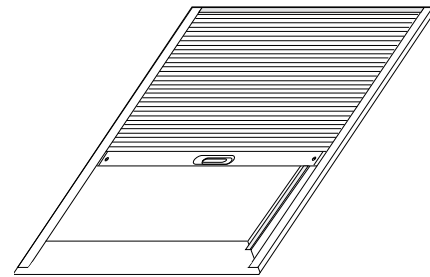
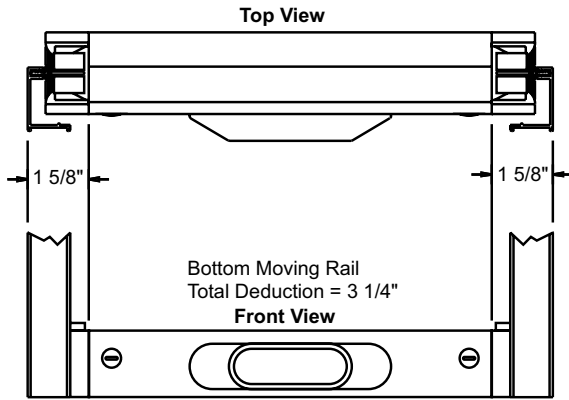
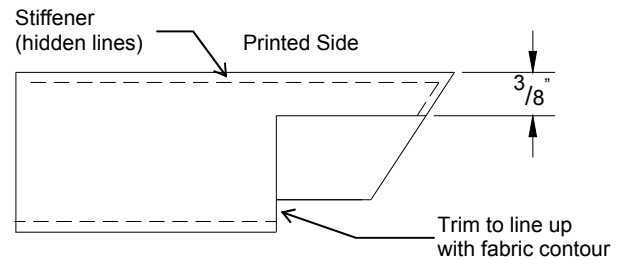

Figure A



Soprano Skylights Moving Rail
Top and Front View

Soprano Fabric Notch (Aspen Only - other fabrics slotted)



Additional trimming for bottom stiffener
(and attached single layer of fabric).

Color Lux® Cellular Specialty Shades
FRENCH DOOR DÉCOR HARDWARE SYSTEM



Deluxe Head Rail

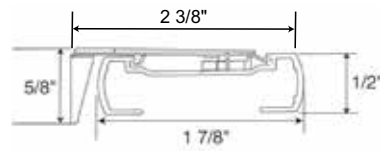

Deluxe Rail

- Depth of rail: 1 7/8"
- Depth of rail and bracket: 2 3/8"
- Height: 1/2"
- Height of bracket: 5/8"

Hardware Features	
Fabric Wrapped Upgrade	Fabric used is same fabric as the shade. Back of rail is white to outside. Frosted clear end caps with fabric insert.
Designer Metallic Upgrade	<ul style="list-style-type: none"> • Oil Rubbed Bronze head, middle, bottom rails and end caps. • Brushed Nickel head, middle, bottom rails and end caps.
Mounting Dimensions	
French Door Decor Hardware System	
Minimum Shallow Mount	3/4"
Minimum Flush Inside Mount	2 3/8"
Minimum Outside Mount	3/4"
Minimum Side Mount	1 3/8"
Recommended Side Mounting Method	<ul style="list-style-type: none"> • See page 21 for recommended mounting method for side mount shades • Width limit for side mount brackets is 48"
Finished Dimensions	
Inside and Side Mount	
	<ul style="list-style-type: none"> • Fabric will measure ordered width less: 3/8" • Head rail* will measure ordered width less: 3/16"
Outside Mount	
	<ul style="list-style-type: none"> • Fabric will measure ordered width • Head rail* will measure ordered width plus: 3/16"
Exact (End Cap to End Cap) Mount	
	<ul style="list-style-type: none"> • Fabric will measure ordered width less: 3/16" • Head rail* will measure ordered width
* Head rail measurements include endcaps. Width and length measurements may vary +/- 1/8"	

Color Lux® Cellular Specialty Shades

FRENCH DOOR DÉCOR HARDWARE SYSTEM

COLORLUX® CELLULAR SHADES

Applications

- Stationary Door Décor
- Movable Door Décor
- Top Down - Bottom Up Door Décor
- Cover French doors, transoms, and side lights.

French Door Décor Hardware Features

- Features two non-moving rails which are mounted in the window or door. A tension control system enables the movable rail to be easily moved with the touch of a finger. The only visible cords are the ones that hold the movable middle rail in place.
- The widest width of the window cannot exceed the narrowest width of the window by more than $\frac{3}{8}$ ".

Stationary Non-Movable French Door Décor Shades

- Top and bottom rails are mounted to the window and are stationary.

Movable French Door Décor Shades

- Top and bottom rails are mounted to the window, one middle movable rail raises from the bottom.

Top Down - Bottom Up Option

- Top and bottom rails are mounted to the window, two movable rails allow the shade to lower from the top and raise from the bottom.
- The non-movable top and bottom rails are attached to the window or door.
- Ideal for entry ways with narrow windows next to doors and other narrow windows that are easily accessible.

Ordering Information for French Door Décor

- Specify IB or OB mount and rail color.
- Specify stationary, movable or Top Down - Bottom Up.

Accessories

- 6' Expandable Pole:
- 12' Expandable Pole:

Specially designed pole end allows for easy operation of French Door Décor Shades.

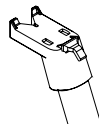

French Door Decor Cellular Shades Hardware

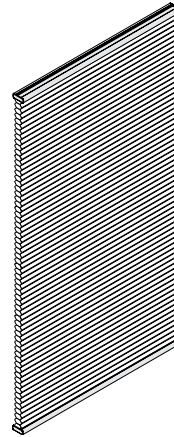

Stationary Non-Movable

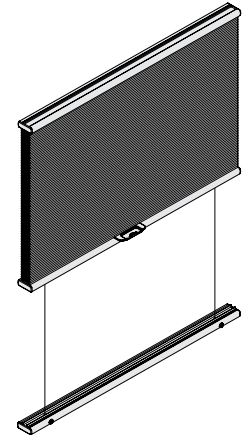

Shown open with movable rail option

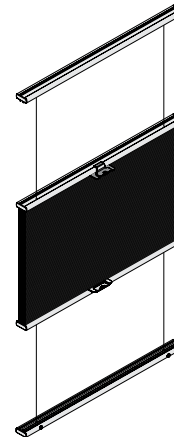

Shown open with Top Down - Bottom Up Option

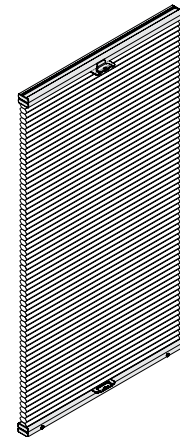

Shown closed with Top Down - Bottom Up Option

Color Lux® Cellular Specialty Shades

DAY-NIGHT SHADES HARDWARE SYSTEM



Deluxe Head Rail

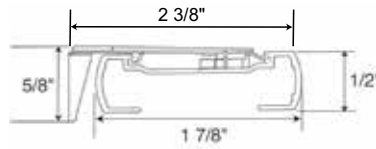

Deluxe Rail

- Depth of rail: 1 7/8"
- Depth of rail and bracket: 2 3/8"
- Height: 1/2"
- Height of bracket: 5/8"

Hardware Features	
Fabric Wrapped Upgrade	Fabric used is same fabric as the shade. Back of rail is white to outside. Frosted clear end caps with fabric insert.
Designer Metallic Upgrade	<ul style="list-style-type: none"> • Oil Rubbed Bronze head and bottom rails with bronze colored tassel, end caps and white cord. • Brushed Nickel head and bottom rails and end caps with coordinating tassel and white cord.
Mounting Dimensions	
Mounting Dimensions	Standard Cord Lock Rail
Minimum Shallow Mount	3/4"
Minimum Flush Inside Mount	2 3/8"
Minimum Outside Mount	3/4"
Minimum Side Mount	1 1/8"
Recommended Side Mounting Method	<ul style="list-style-type: none"> • See page 21 for recommended mounting method for side mount shades • Width limit for side mount brackets is 48"
Finished Dimensions	
Inside and Side Mount	
	<ul style="list-style-type: none"> • Fabric will measure ordered width less: 3/8" • Head rail* will measure ordered width less: 3/16"
Outside Mount	
	<ul style="list-style-type: none"> • Fabric will measure ordered width • Head rail* will measure ordered width plus: 3/16"
Exact (End Cap to End Cap) Mount	
	<ul style="list-style-type: none"> • Fabric will measure ordered width less: 3/16" • Head rail* will measure ordered width
* Head rail measurements include endcaps. Width and length measurements may vary +/- 1/8"	

Applications

- Standard Rectangular with cellular fabrics only.

Day - Night Shade Specifications

Refer to the appropriate fabric sections for proper pricing.

Color Lux® Cellular Specialty Shades

DAY-NIGHT SHADES HARDWARE SYSTEM

COLORLUX® CELLULAR SHADES

Rail Colors and Cord Colors

- **Color Coordinated Rail Shades:** The top rail and middle rail will coordinate with top fabric and bottom rail will coordinate with the bottom fabric. The cord and tassel will be white. Not available with Color Lux Shades.
- **Designer Metallic Hardware Shades:** All rails, end caps and tassels will be the selected metallic color. Cords will be white.
- **Fabric Wrapped Rail Shades:** The top rail and middle rail will coordinate with top fabric and bottom rail will coordinate with the bottom fabric. The cord and tassel will be white. End caps and cord lock will be color coordinated.

Hardware Options

- Cord Lock

Ordering Information for Day - Night Shade

- Specify fabrics, top and bottom panels.
- Specify IB or OB mount and rail color.

TOP FABRIC

CELLULAR	Width		Length	
	Min	Max	Min	Max
Verona	12"	72"	18"	96"
Boutique	12"	72"	18"	96"
Baritone (all)*	12"	72"	18"	96"
Debut ½" Double Cell Light Filtering	12"	72"	18"	96"
Debut ¾" Single Cell Light Filtering	12"	72"	18"	96"
Color Lux Linen Weave Light Filtering*	12"	72"	18"	96"
Color Lux Linen Weave Room Darkening*	NA	NA	NA	NA
Linen Weave Light Filtering*	12"	72"	18"	96"
Linen Weave Room Darkening*	NA	NA	NA	NA
Premiere ¾" Single Cell Blackout	NA	NA	NA	NA
Premiere ¾" Single Cell Light Filtering	12"	72"	18"	96"
NEW Aspen	12"	72"	18"	96"

BOTTOM FABRIC

Width		Length	
Min	Max	Min	Max
12"	72"	18"	96"
12"	72"	18"	96"
12"	72"	18"	96"
12"	72"	18"	96"
12"	72"	18"	96"
12"	72"	18"	96"
12"	72"	18"	96"
12"	72"	18"	96"
12"	72"	18"	96"
12"	72"	18"	96"
12"	72"	18"	96"
12"	72"	18"	96"
12"	72"	18"	96"
12"	72"	18"	96"

* Day-Night Shades can only be built in conjunction with other ¾" cellular fabrics. All Debut includes print patterns: Strie, Terazzo, Angel Hair, Strat, Florance, Blossom, Country Woven and Homespun.

Color Lux® Cellular Shades

HIGHLIGHTS CORNICE VALANCE

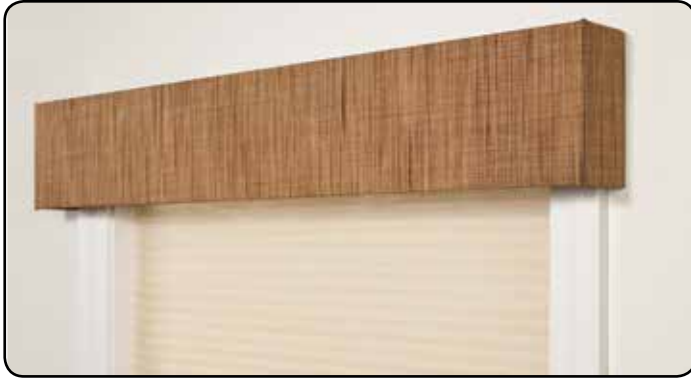

Highlights Cornice Valances

Highlight any element of your home décor with the Highlights Cornice Valance upgrade.

This tailored, fabric wrapped 6-inch valance, available with seven returns sized from 1½" to 6", mounts over any product, either inside or outside the frame. The keystone option now allows for all Color Lux Roller fabrics to cover widths up to 216".

Highlights Valance without a keystone can be added to your cellular shade order or as a stand alone product. Highlights Valance orders with a keystone are a stand alone product only.

See page 101 for more information.

Color Lux® Cellular Shades

EZ LEVEL

EZ Level makes quick work of leveling without cords to cut or tuck into a rail. No special tools needed – just use a nickel, quarter or penny to adjust plug on the bottom rail.

EZ Level is standard on all Cellular and Pleated Shades with the following hardware systems:

- Standard and Deluxe Cord Lock
- Cordless Ultra
- Cord Loop
- SlumberShades
- Simplicity Motorized Systems

EZ Level is not available with Lift & Lock Cordless.

How does EZ Level work?

- Slightly raise the bottom rail you want to level.
- Insert a coin or flat head screwdriver into the adjustment screw and turn it.
- Turn the adjustment screw clockwise or counter clockwise to make slight adjustments up or down. One quarter turn of the adjustment screw will move the bottom rail up or down ¼".
- Lower the rail to check the level and make further adjustments if necessary.









COLOR LUX® ROLLER SHADES







COLORLUX® ROLLER SHADES

COLOR LUX[®]
Designer Cellular & Roller Shades





	Key Features	Control Options	Hardware Color Options	Hardware Size (Depth x Height)	Roll Style
Skyline Roller Only 	<ul style="list-style-type: none"> • Skyline System • Sturdy aluminum tube for durability • Perfect under top treatments • Cord loop length does not change while operating shade 	<ul style="list-style-type: none"> • Cord Loop • Motorization 	<ul style="list-style-type: none"> • White, • Vanilla, • Black, • Bronze and • Satin Nickel Clutch, Bracket Covers, Bead Chain and Tensioner	Standard 2½" x 2¾" 2¼" x 2⅞"	Standard Reverse
Designer Cassette with Fabric Insert Strip 	<ul style="list-style-type: none"> • Cassette head rail features a matching fabric insert • Hides the roller shade mechanism for a tailored appearance 	<ul style="list-style-type: none"> • Cord Loop • Cordless • Motorization 	<ul style="list-style-type: none"> • White • Ivory • Black • Satin Nickel • Oil Rubbed Bronze All with fabric insert strip	3¾" x 2⅞"	Standard
Designer Cassette with Fabric Wrap 	<ul style="list-style-type: none"> • Head rail is wrapped with matching shade fabric • Head rail is white, black or oil rubbed bronze beneath the fabric wrap • Hides the mechanism for a soft appearance from top to bottom 	<ul style="list-style-type: none"> • Cord Loop • Cordless • Motorization 	<ul style="list-style-type: none"> • White • Ivory • Black • Satin Nickel • Oil Rubbed Bronze All with fabric wrap	3¾" x 2⅞"	Standard
Designer Cassette with Metallic Finish 	<ul style="list-style-type: none"> • Smooth finish head rail hides the roller shade mechanism • High quality finish for a modern appearance 	<ul style="list-style-type: none"> • Cord Loop • Cordless • Motorization 	<ul style="list-style-type: none"> • White • Ivory • Black • Satin Nickel • Oil Rubbed Bronze 	3¾" x 2⅞"	Standard
NEW FeatherTouch Cordless 	<ul style="list-style-type: none"> • Precision alignment across all shades • Smooth operation • Safe for homes with children and pets • Magnetic wand for hard to reach places 	<ul style="list-style-type: none"> • Cordless 	<ul style="list-style-type: none"> • White • Black • Designer Nickel 	Varies see page 81	Standard
Cordless with Deco-Bar 	<ul style="list-style-type: none"> • Cord-free system • Operates like a spring roller shade with a gentle pull on the bottom rail to raise and lower the shade • Smooth and quiet operation • Ideal from homes with children and pets • Clear handle included to ensure clean bottom rail 	<ul style="list-style-type: none"> • Cordless 	<ul style="list-style-type: none"> • White • Black • Ivory • Satin Nickel • Bronze Color Coordinated Bracket Covers	Shades to 72" (varies by fabric) 1½" x 2¼" Over 72" (varies by fabric) 1¾" x 2¾"	Standard Reverse
7.4V Rechargeable PowerTouch 	<ul style="list-style-type: none"> • Raise & lower shading with the push of a button • Eliminate the need to stand by the shading to operate; just touch and go • Favorite position button • Rechargeable battery with recharge port on pendant • Features a favorite position 	<ul style="list-style-type: none"> • Simplicity 	<ul style="list-style-type: none"> • Skyline Roller • Designer Cassette (All) • Wand and Pendant available in white or black 	Designer Cassette: 3¾" x 2⅞" No Head Rail: Varies by shade size	Standard Reverse with Standard Roller

Color Lux® Roller Shades

HARDWARE OPTIONS

	Key Features	Control Options	Hardware Color Options	Hardware Size (Depth x Height)	Roll Style
7.4V Rechargeable Simplicity Motorization 	<ul style="list-style-type: none"> Rechargeable motor is fully integrated within the roller tube No additional battery wand needs to be installed Battery lasts 6 to 12 months between charges (varies by size and usage) 	<ul style="list-style-type: none"> Simplicity 	<ul style="list-style-type: none"> Standard Roller Designer Cassette (All) 	Minimum Shade Width is 18" Max size varies by fabric	Standard Reverse with Standard Roller
4" Skyline Fascia 	<ul style="list-style-type: none"> Conceals the Skyline Roller hardware system Cornice look Cord Loop and Motorization Fascia coordinates with all Skyline colors 	<ul style="list-style-type: none"> Cord Loop Motorization 	<ul style="list-style-type: none"> Black Brushed Nickel Vanilla Bronze White 	4" x 4"	Standard
Simplicity Wave for Roller Shades 	<ul style="list-style-type: none"> Rechargeable motor is fully integrated within the roller tube Motor is operated via a separate wand that operates the shade with a touch of the head rail. Easy operation for hard to reach places 	<ul style="list-style-type: none"> Simplicity 	<ul style="list-style-type: none"> Designer Cassette (All) See above for color options	Minimum Shade Width is 18" Max size varies by fabric	Standard
Designer Cassette with Retractable Cord 	<ul style="list-style-type: none"> Cords are white or black and coordinate with the clutch selected Smooth and simple operation Does not require a cord tensioner Ideal for out of reach shades 	<ul style="list-style-type: none"> White or Black Retractable Cord Left or Right hand control 	<ul style="list-style-type: none"> White Ivory Black Satin Nickel Oil Rubbed Bronze 	3¾" x 2⅞"	Standard

COLOR LUX ROLLER DECORATIVE OPTIONS

Highlights Cornice Valances 	<ul style="list-style-type: none"> Additional heights available! 8", 10", 12", 14" and 16" options Keystone for widths up to 216". Available in all Color Lux Roller Fabrics Coordinate all your shades and décor for a unified look Hide any roller hardware mechanism 	<ul style="list-style-type: none"> Available as inside and outside mount Seven return options to fit any window 	<ul style="list-style-type: none"> Fabric Wrapped 	Width: 24" to 216" (includes returns) Height: various Returns: 1½" to 6"	NA
Bottom Rails 	<ul style="list-style-type: none"> Add an a decorative accent to bottom of your shade or fabric wrap the bottom rail for a soft look. Two clear plastic end caps secure the fabric in place. 	All hardware	<ul style="list-style-type: none"> White Black Bronze Aluminum Vanilla For fabric wrap, rail colors are street side only	NA	NA
Reverse Roll 	<ul style="list-style-type: none"> The fabric rolls from the front of the roller, concealing the hardware. 	<ul style="list-style-type: none"> Standard Roller Cordless Deco-Bar Standard Roller with Motorization 	See page 80 for color options for your hardware selection	See page 75 & 77 for hardware size	NA
Standard Roll 	<ul style="list-style-type: none"> Fabric rolls off the back of the roller 	<ul style="list-style-type: none"> Standard Roller Cordless Deco-Bar Motorization 	See page 80 for color options for your hardware selection	See page 75 & 77 for hardware size	NA

Color Lux® Roller Shades

SKYLINE HARDWARE OPTIONS

Color Lux provides beautiful color coordination for various hardware options to provide ultimate roller shade design and quality. White, Ivory and Black Skyline hardware is standard on all Color Lux Roller shades. All components are color coordinated, including clutch, bracket covers, bead chain and the tensioner. See individual price grids for pricing.

Skyline Hardware in White



Designer Cassette with Skyline Hardware



Standard Roller with Skyline Hardware



4" Skyline Fascia

Clutch, Cassette, Bead Chain, Brackets, Bracket Covers and Tensioner are in White

Skyline Hardware in Ivory



Designer Cassette with Skyline Hardware



Standard Roller with Skyline Hardware



4" Skyline Fascia

Clutch, Cassette, Bead Chain, Brackets, Bracket Covers and Tensioner are in Ivory

Skyline Hardware in Black



Designer Cassette with Skyline Hardware



Standard Roller with Skyline Hardware



4" Skyline Fascia

Clutch, Cassette, Bead Chain, Brackets, Bracket Covers and Tensioner are in Black

Color Lux® Roller Shades

SKYLINE HARDWARE OPTIONS

Skyline Hardware in Satin Nickel



Designer Cassette with Skyline Hardware



Standard Roller with Skyline Hardware

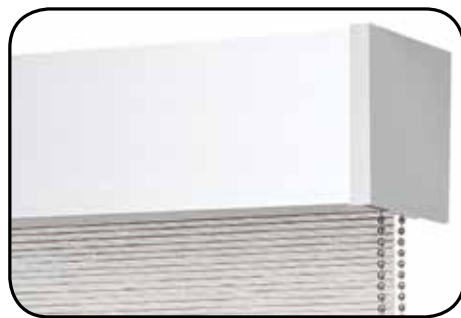

4" Skyline Fascia

Clutch, Cassette, Bead Chain, Bracket. Bracket Covers and Tensioner are in Satin Nickel.

Skyline Hardware in Bronze



Designer Cassette with Skyline Hardware



Standard Roller with Skyline Hardware



4" Skyline Fascia

Clutch, Cassette, Bead Chain, Brackets, Bracket Covers and Tensioner are in Bronze

Dual Roller Shades



Black and White Brackets



Mix and Match Light Filtering and Blackout Fabrics

Dual Roller Shades are available with Remote Motorization and Cord Loop Control

FABRIC INFORMATION

Choosing the Right Color Lux Roller Fabric

What are the fabric contents of each fabric?

- Classic Duck Light Filtering is 100% Polyester
- Classic Duck Blackout is 100% Polyester
- Linen Light Filtering is 100% Polyester
- Linen Blackout is 100% Polyester with a foam coated backing
- Solar Screen 5 is 36% Polyester, 51% FR Polyester and 13% Cationic Polyester

Classic Duck Light Filtering and Blackout Fabrics

Classic Duck provides the perfect canvas for all 800 Color Lux colors. A simple weave works well with any complementary fabric textures. Available in Light Filtering and Blackout.

Linen Light Filtering and Blackout Fabrics

Linen provides the natural timeless look of linen fabric into Color Lux Roller Shades. Light Filtering allows in just the right amount of opacity to maintain privacy but allow light into the home. Linen Blackout is perfect for bedroom and media room applications.

Solar Screen 5 Fabric

Solar Screen 5 is the perfect balance of function and design. With a 5% openness factor, Solar Screen 5 provides light and privacy. Color Lux Color 100 Ultra White has passed the NFPA and California Title 19 Fire Rating Standards. Solar Screen 5 also offers a subtle linen texture that enhances every decor style.

What are the fabric properties of Solar Screen 5?

The below ratings apply to **Color Lux Color 100 Ultra White Only**

	TS	RS	AS	TV	OF	SHGC/G Value		Fire Rating
						Commercial SHGC % Improvement	Residential SHGC	
Solar Screen 5								
100 Ultra White*	39	56	5	38	5.00	39%	0.42	NFPA 701-10 TM#1, California U.S. Title 19
ISO 14001:2004								
OEKO-TEX® Standard 100								
OEKO-TEX® Standard 1000								
Zero Landfill								
Water Conservation and Usage								
Use of Recycled Materials								

* Fire Rating and other properties apply to Ultra White (Color Lux Color 100) only

To be certified with OEKO-TEX® Standard 100, companies hve to meet defined criteria regarding their environmentally friendly and socially acceptable production process at all production stages (International Association for Reseach and Testing in the Field of Textile Ecology)

- TS = Solar Transmittance
- RS = Solar Reflectance
- AS = Solar Absorptance
- TV = Visual Transmittance
- OF= Openness Factor
- 1/4 CL = 1/4" Clear Glass
- 1/4 HA = 1/4" Heat Absorbing Glass

COLORLUX® ROLLER SHADES

Skyline Standard Roller Shade

Price Group 19 | Classic Duck Light Filtering

		Width In Inches																				
		24	30	36	42	48	54	60	66	72	78	84	90	96	102	106	112	118	124	130	136	144
Length In Inches	36	236	262	291	323	359	397	442	498	553	620	706	777	837	905	976	998	1188	1297	1415	1547	1688
	42	241	269	298	332	368	409	453	512	569	637	723	796	859	929	1003	1023	1220	1331	1456	1587	1736
	48	249	276	307	342	379	421	465	525	584	653	743	818	883	953	1030	1049	1252	1366	1492	1630	1778
	54	258	283	314	349	387	428	478	538	598	669	763	837	907	979	1057	1078	1284	1402	1530	1672	1826
	60	262	291	323	358	397	441	490	553	615	687	780	858	927	1001	1081	1102	1315	1437	1570	1712	1846
	66	269	297	331	366	408	452	501	564	627	703	798	881	949	1026	1108	1132	1349	1472	1606	1755	1871
	72	274	306	337	378	417	462	513	580	644	720	820	899	974	1049	1136	1157	1381	1508	1644	1798	1899
	78	282	312	348	384	425	473	525	593	657	739	837	920	995	1075	1159	1185	1413	1541	1683	1805	2063
	84	288	319	353	391	436	485	538	604	674	753	857	944	1018	1100	1186	1211	1444	1577	1625	1810	2125
	90	295	326	362	402	446	495	549	620	688	771	875	963	1041	1144	1224	1238	1476	1613	1661	1826	2189
	96	300	333	369	413	456	505	560	634	701	787	895	985	1063	1192	1254	1265	1509	1647	1696	2036	2255
	102	311	345	381	423	469	522	580	653	726	804	915	1006	1086	1223	1280						
	108	316	351	390	431	480	532	590	666	741	821	933	1026	1108	1231	1322						
	114	322	357	395	440	490	543	602	680	756	837	953	1046	1133	1260	1360						
120	329	365	406	450	500	554	615	693	771	854	971	1069	1154	1280	1411							
126	335	373	414	461	508	565	626	707	786	871	990	1089	1180	1309	1429							
132	345	381	423	469	520	579	640	721	801	889	1010	1111	1202	1335	1509							
138	351	388	430	478	529	589	652	735	818	907	1030	1134	1224	1356	1536							
144	357	394	438	489	539	600	664	750	833	922	1049	1156	1251	1410	1577							

Classic Duck Light Filtering: Minimum standard shade size is 12" x 12". Maximum shade width is 108" and it can be railroaded to a maximum width of 144" and a maximum length of 96".

Head Rail Options and Surcharges

Section 1 & 2	Available: Skyline Hardware (All), Designer Cassette (All), Cordless Deco-Bar, 4" Skyline Fascia, Motorization, PowerTouch Rechargeable
Section 3	Available: Skyline Roller Only with Cordloop, Heavy Duty Motorization (Roller Only), 4" Skyline Fascia with Cord Loop (Dual Roller Not Available)
Section 4	Available: Skyline Roller Only with Cordloop, and Heavy Duty Motorization (Roller Only) (Dual Roller Not Available)

Roller Only Options

Skyline Clutch (White, Ivory, Black)	No Additional Surcharge
Skyline Clutch (Satin Nickel and Bronze)	\$28
Skyline Dual Roller (Price two separate shades, then add surcharge)	\$28
Cordless with White, Ivory and Black Deco-Bar	\$42
Cordless with Bronze and Satin Nickel Deco-Bar	\$63
NEW FeatherTouch™ Cordless with EZ Mount Hardware in White and Black	\$42
NEW FeatherTouch™ Cordless with EZ Mount Hardware in Designer Nickel	\$63
Spring Assist for Shades over 84" x 84" (White or Black Clutch)	\$130
Scotchgard™ Stain Protection for Roller Shades	\$38

Cordless Specifications:
Minimum width is 15½"; Maximum Width is 96";
Maximum Length is 96"

FeatherTouch Cordless Specifications:
Minimum width is 19"; If width is 30" or less, then
maximum length is 61". If width is over 30", then
maximum length is 84".

Designer Cassette and Fascia Options

	24	30	36	42	48	54	60	66	72	78	84	90	96	102	108	114	120
White, Ivory, Black, Satin Nickel, and Oil Rubbed Bronze Includes Smooth Face, Insert Strip and Fabric Wrap	78	84	90	97	103	111	119	126	133	128	135	147	152	156	162	185	208
4" Skyline Fascia	64	70	72	74	84	97	106	117	128	137	149	162	169	179	191	201	210
Cordless, FeatherTouch™ & Retractable Cord with Cassette	Add \$42 PLUS the Designer Cassette Surcharge for all operating options																

Highlights Cornice Valance

	24	30	36	42	48	54	60	66	72	78	84	94	96	102	108	114	120	132	144
6" & 8" Highlights Cornice Valance (No Keystone)	147	163	178	194	210	219	231	242	253	263	275	293	Requires Keystone. See pricing below						
6" & 8" Highlights Cornice Valance (with ONE Keystone)	198	214	230	244	261	271	282	295	303	315	326	345	349	360	370	381	393	409	419
10" - 16" Highlights Cornice Valance (No Keystone)	198	220	241	262	284	296	312	326	341	355	372	395	Requires Keystone. See pricing below						
10" - 16" Highlights Cornice Valance (with ONE Keystone)	267	289	311	329	352	366	381	398	409	425	441	465	471	486	500	515	530	552	566

Motorization: Available with Designer Cassette, 4" Skyline Fascia, and Standard Roller

	Reference
PowerTouch Rechargeable	\$118 per shade pg. 93
Simplicity Wave	\$121 per shade pg. 90
Simplicity Rechargeable & Non-Rechargeable Motorization	\$319 per shade pg. 95
Simplicity Rechargeable Heavy Duty Motorization	\$434 per shade pg. 96
Simplicity Low Voltage Hard Wired Transformer	\$74 per transformer pg. 98
Simplicity 5 Channel Remote	\$41 per remote pg. 100
Simplicity 6 Channel Timer Remote	\$67 per remote pg. 100
Simplicity 14 Channel Remote	\$67 per remote pg. 100
Simplicity Smart Controller	\$336 per controller pg. 35
NEW EZ Charge Wand and Receiver	\$37/\$20 each pg. 97
Solar Panel	\$105 per panel pg. 96
Telescoping Wand for Simplicity Wave	\$32 per wand pg. 90
Charger for Simplicity Rechargeable Motor	\$28 per charger pg. 95
Charger for Heavy Duty Rechargeable Motor	\$59 per charger pg. 96

- Tube Information for Clutch Operated Shades Only**
- **Section 1:** Shades to the left of the dashed line requires a 1" tube/ SL10" clutch
 - **Section 2:** Shades to the right of the dashed line requires a 1½" tube/ SL10 clutch
 - **Section 3:** Shades in the blue section requires a 2" tube/SL20 clutch.
 - **Section 4:** Shades in the orange section requires a 2½" tube/Galaxy 200 clutch

COLORLUX® ROLLER SHADES

Skyline Standard Roller Shade

Price Group 20 | Classic Duck Blackout

Width In Inches

	24	30	36	42	48	54	60	66	72	78	84	90	96	102	106	112	118	124	130	136	144
36	262	291	323	358	398	442	491	553	615	689	782	863	928	1004	1083	1107	1319	1441	1572	1718	1872
42	268	298	331	368	410	454	504	569	631	708	803	884	954	1032	1113	1136	1355	1477	1617	1761	1927
48	276	306	343	379	420	468	516	583	648	726	824	907	980	1059	1144	1166	1389	1517	1657	1808	1976
54	287	314	348	387	431	477	530	597	663	743	848	928	1007	1087	1173	1200	1426	1557	1698	1855	2106
60	291	323	358	397	442	490	543	615	682	763	866	952	1029	1111	1201	1223	1460	1595	1742	1900	2246
66	298	330	367	408	452	501	557	626	697	781	887	977	1054	1139	1231	1255	1500	1633	1782	2025	2394
72	305	342	377	419	462	513	570	643	714	798	911	998	1080	1166	1262	1283	1532	1674	1825	2160	2552
78	313	346	386	425	473	525	583	659	731	820	928	1022	1104	1192	1287	1315	1569	1712	1946	2303	2721
84	319	354	391	435	483	538	597	672	747	836	951	1047	1132	1219	1317	1344	1603	1750	2074	2454	2900
90	328	362	402	446	495	550	609	688	765	855	971	1069	1155	1270	1361	1374	1640	1865	2212	2615	3092
96	333	369	412	457	507	560	621	703	778	873	994	1094	1181	1325	1393	1403	1676	1988	2358	2788	3295
102	346	382	423	470	521	580	644	726	806	954	1087	1193	1290	1453	1520						
108	350	390	432	478	533	590	655	740	822	975	1110	1218	1317	1461	1570						
114	358	395	439	489	543	602	669	755	838	928	1059	1160	1256	1398	1508						
120	365	406	450	500	555	615	682	771	855	948	1077	1186	1281	1421	1566						
126	373	414	460	511	564	627	694	785	871	968	1100	1209	1309	1453	1586						
132	382	423	470	521	576	642	710	800	889	986	1121	1234	1333	1482	1618						
138	390	430	477	531	588	654	725	818	907	1007	1144	1259	1361	1505	1650						
144	395	438	486	542	599	667	739	833	924	1025	1166	1283	1389	1565	1683						

Classic Duck Blackout: Minimum standard shade size is 12" x 12". Maximum shade width is 108" and it can be railroded to a maximum width of 144" and a maximum length of 96"

Head Rail Options and Surcharges

Section 1 & 2	Available: Skyline Hardware (All), Designer Cassette (All), Cordless Deco-Bar, 4" Skyline Fascia, Motorization, PowerTouch Rechargeable
Section 3	Available: Skyline Roller Only with Cordloop, Heavy Duty Motorization (Roller Only), 4" Skyline Fascia with Cord Loop (Dual Roller Not Available)
Section 4	Available: Skyline Roller Only with Cordloop, and Heavy Duty Motorization (Roller Only) (Dual Roller Not Available)

Roller Only Options

Skyline Clutch (White, Ivory, Black)	No Additional Surcharge
Skyline Clutch (Satin Nickel and Bronze)	\$28
Skyline Dual Roller (Price two separate shades, then add surcharge)	\$28
Cordless with White, Ivory and Black Deco-Bar	\$42
Cordless with Bronze and Satin Nickel Deco-Bar	\$63
NEW FeatherTouch™ Cordless with EZ Mount Hardware in White and Black	\$42
NEW FeatherTouch™ Cordless with EZ Mount Hardware in Designer Nickel	\$63
Spring Assist for Shades over 84" x 84" (White or Black Clutch)	\$130
Scotchgard™ Stain Protection for Roller Shades	\$38

Cordless Specifications:
Minimum width is 15½"; Maximum Width is 96";
Maximum Length is 96"

FeatherTouch Cordless Specifications:
Minimum width is 17"; If width is 26" or less, then maximum length is 53". If width is over 26", then maximum length is 84".

Designer Cassette and Fascia Options

	24	30	36	42	48	54	60	66	72	78	84	90	96	102	108	114	120
White, Ivory, Black, Satin Nickel, and Oil Rubbed Bronze Includes Smooth Face, Insert Strip and Fabric Wrap	78	84	90	97	103	111	119	126	133	128	135	147	152	156	162	185	208
4" Skyline Fascia	64	70	72	74	84	97	106	117	128	137	149	162	169	179	191	201	210
Cordless, FeatherTouch™ & Retractable Cord with Cassette	Add \$42 PLUS the Designer Cassette Surcharge for all operating options																

Highlights Cornice Valance

	24	30	36	42	48	54	60	66	72	78	84	94	96	102	108	114	120	132	144
6" & 8" Highlights Cornice Valance (No Keystone)	147	163	178	194	210	219	231	242	253	263	275	293	Requires Keystone. See pricing below						
6" & 8" Highlights Cornice Valance (with ONE Keystone)	198	214	230	244	261	271	282	295	303	315	326	345	349	360	370	381	393	409	419
10" - 16" Highlights Cornice Valance (No Keystone)	198	220	241	262	284	296	312	326	341	355	372	395	Requires Keystone. See pricing below						
10" - 16" Highlights Cornice Valance (with ONE Keystone)	267	289	311	329	352	366	381	398	409	425	441	465	471	486	500	515	530	552	566

Motorization: Available with Designer Cassette, 4" Skyline Fascia, and Standard Roller

	Reference
PowerTouch Rechargeable	\$118 per shade pg. 93
Simplicity Wave	\$121 per shade pg. 90
Simplicity Rechargeable & Non-Rechargeable Motorization	\$319 per shade pg. 95
Simplicity Rechargeable Heavy Duty Motorization	\$434 per shade pg. 96
Simplicity Low Voltage Hard Wired Transformer	\$74 per transformer pg. 98
Simplicity 5 Channel Remote	\$41 per remote pg. 100
Simplicity 6 Channel Timer Remote	\$67 per remote pg. 100
Simplicity 14 Channel Remote	\$67 per remote pg. 100
Simplicity Smart Controller	\$336 per controller pg. 35
NEW EZ Charge Wand and Receiver	\$37/\$20 each pg. 97
Solar Panel	\$105 per panel pg. 96
Telescoping Wand for Simplicity Wave	\$32 per wand pg. 90
Charger for Simplicity Rechargeable Motor	\$28 per charger pg. 95
Charger for Heavy Duty Rechargeable Motor	\$59 per charger pg. 96

- Tube Information for Clutch Operated Shades Only**
- Section 1: Shades to the left of the dashed line requires a 1" tube/SL10" clutch
 - Section 2: Shades to the right of the dashed line requires a 1½" tube/SL10 clutch
 - Section 3: Shades in the blue section requires a 2" tube/SL20 clutch.
 - Section 4: Shades in the orange section requires a 2½" tube/Galaxy 200 clutch

Skyline Standard Roller Shade

Price Group 21 | Linen Light Filtering

		Width In Inches																					
		24	30	36	42	48	54	60	66	72	78	84	90	96	102	106	112	118	124	130	136	144	
Length In Inches	36	236	262	291	323	359	397	442	498	553	620	706	777	837	905	976	998	1188	1297	1415	1547	1688	
	42	241	269	298	332	368	409	453	512	569	637	723	796	859	929	1003	1023	1220	1331	1456	1587	1736	
	48	249	276	307	342	379	421	465	525	584	653	743	818	883	953	1030	1049	1252	1366	1492	1630	1778	
	54	258	283	314	349	387	428	478	538	598	669	763	837	907	979	1057	1078	1284	1402	1530	1672	1826	
	60	262	291	323	358	397	441	490	553	615	687	780	858	927	1001	1081	1102	1315	1437	1570	1712	1846	
	66	269	297	331	366	408	452	501	564	627	703	798	881	949	1026	1108	1132	1349	1472	1606	1755	1871	
	72	274	306	337	378	417	462	513	580	644	720	820	899	974	1049	1136	1157	1381	1508	1644	1798	1899	
	78	282	312	348	384	425	473	525	593	657	739	837	920	995	1075	1159	1185	1413	1541	1683	1805	2063	
	84	288	319	353	391	436	485	538	604	674	753	857	944	1018	1100	1186	1211	1444	1577	1625	1810	2125	
	90	295	326	362	402	446	495	549	620	688	771	875	963	1041	1144	1224	1238	1476	1613	1661	1826	2189	
	96	300	333	369	413	456	505	560	634	701	787	895	985	1063	1192	1254	1265	1509	1647	1696	2036	2255	
	102	311	345	381	423	469	522	580	653	726	804	915	1006	1086	1223	1280							
	108	316	351	390	431	480	532	590	666	741	821	933	1026	1108	1231	1322							
	114	322	357	395	440	490	543	602	680	756	837	953	1046	1133	1260	1360							
120	329	365	406	450	500	554	615	693	771	854	971	1069	1154	1280	1411								
126	335	373	414	461	508	565	626	707	786	871	990	1089	1180	1309	1429								
132	345	381	423	469	520	579	640	721	801	889	1010	1111	1202	1335	1509								
138	351	388	430	478	529	589	652	735	818	907	1030	1134	1224	1356	1536								
144	357	394	438	489	539	600	664	750	833	922	1049	1156	1251	1410									

Color Lux Linen Light Filtering: Minimum standard shade size is 12" x 12". Maximum shade width is 116" and it can be railroaded to a maximum width of 144" and a maximum length of 104".

Head Rail Options and Surcharges

Section 1 & 2	Available: Skyline Hardware (All), Designer Cassette (All), Cordless Deco-Bar, 4" Skyline Fascia, Motorization, PowerTouch Rechargeable
Section 3	Available: Skyline Roller Only with Cordloop, Heavy Duty Motorization (Roller Only), 4" Skyline Fascia with Cord Loop (Dual Roller Not Available)
Section 4	Available: Skyline Roller Only with Cordloop, and Heavy Duty Motorization (Roller Only) (Dual Roller Not Available)

Roller Only Options

Skyline Clutch (White, Ivory, Black)	No Additional Surcharge
Skyline Clutch (Satin Nickel and Bronze)	\$28
Skyline Dual Roller (Price two separate shades, then add surcharge)	\$28
Cordless with White, Ivory and Black Deco-Bar	\$42
Cordless with Bronze and Satin Nickel Deco-Bar	\$63
NEW FeatherTouch™ Cordless with EZ Mount Hardware in White and Black	\$42
NEW FeatherTouch™ Cordless with EZ Mount Hardware in Designer Nickel	\$63
Spring Assist for Shades over 84" x 84" (White or Black Clutch)	\$130
Scotchgard™ Stain Protection for Roller Shades	\$38

Cordless Specifications:
Minimum width is 15½"; Maximum Width is 96";
Maximum Length is 96"

FeatherTouch Cordless Specifications:
Minimum width is 20"; If width is 30" or less, then
maximum length is 57". If width is over 30", then
maximum length is 84".

Designer Cassette and Fascia Options

	24	30	36	42	48	54	60	66	72	78	84	90	96	102	108	114	120
White, Ivory, Black, Satin Nickel, and Oil Rubbed Bronze Includes Smooth Face, Insert Strip and Fabric Wrap	78	84	90	97	103	111	119	126	133	128	135	147	152	156	162	185	208
4" Skyline Fascia	64	70	72	74	84	97	106	117	128	137	149	162	169	179	191	201	210
Cordless, FeatherTouch™ & Retractable Cord with Cassette	Add \$42 PLUS the Designer Cassette Surcharge for all operating options																

Highlights Cornice Valance

	24	30	36	42	48	54	60	66	72	78	84	94	96	102	108	114	120	132	144
6" & 8" Highlights Cornice Valance (No Keystone)	147	163	178	194	210	219	231	242	253	263	275	293	Requires Keystone. See pricing below						
6" & 8" Highlights Cornice Valance (with ONE Keystone)	198	214	230	244	261	271	282	295	303	315	326	345	349	360	370	381	393	409	419
10" - 16" Highlights Cornice Valance (No Keystone)	198	220	241	262	284	296	312	326	341	355	372	395	Requires Keystone. See pricing below						
10" - 16" Highlights Cornice Valance (with ONE Keystone)	267	289	311	329	352	366	381	398	409	425	441	465	471	486	500	515	530	552	566

Motorization: Available with Designer Cassette, 4" Skyline Fascia, and Standard Roller

Add Motorization surcharges to base shade price, plus desired hardware options

	Price	Unit	Reference
PowerTouch Rechargeable	\$118	per shade	pg. 93
Simplicity Wave	\$121	per shade	pg. 90
Simplicity Rechargeable & Non-Rechargeable Motorization	\$319	per shade	pg. 95
Simplicity Rechargeable Heavy Duty Motorization	\$434	per shade	pg. 96
Simplicity Low Voltage Hard Wired Transformer	\$74	per transformer	pg. 98
Simplicity 5 Channel Remote	\$41	per remote	pg. 100
Simplicity 6 Channel Timer Remote	\$67	per remote	pg. 100
Simplicity 14 Channel Remote	\$67	per remote	pg. 100
Simplicity Smart Controller	\$336	per controller	pg. 35
NEW EZ Charge Wand and Receiver	\$37/\$20	each	pg. 97
Solar Panel	\$105	per panel	pg. 96
Telescoping Wand for Simplicity Wave	\$32	per wand	pg. 90
Charger for Simplicity Rechargeable Motor	\$28	per charger	pg. 95
Charger for Heavy Duty Rechargeable Motor	\$59	per charger	pg. 96

Tube Information for Clutch Operated Shades Only

- **Section 1:** Shades to the left of the dashed line requires a 1" tube/SL10" clutch
- **Section 2:** Shades to the right of the dashed line requires a 1½" tube/SL10 clutch
- **Section 3:** Shades in the blue section requires a 2" tube/SL20 clutch.
- **Section 4:** Shades in the orange section requires a 2½" tube/Galaxy 200 clutch

Skyline Standard Roller Shade

Price Group 22 | Linen Blackout

Width In Inches

	24	30	36	42	48	54	60	66	72	78	84	90	96	102	106	112	118	124	130	136	144
36	262	291	323	358	398	442	491	553	615	689	782	863	928	1004	1083	1107	1319	1441	1572	1718	1872
42	268	298	331	368	410	454	504	569	631	708	803	884	954	1032	1113	1136	1355	1477	1617	1761	1927
48	276	306	343	379	420	468	516	583	648	726	824	907	980	1059	1144	1166	1389	1517	1657	1808	1976
54	287	314	348	387	431	477	530	597	663	743	848	928	1007	1087	1173	1200	1426	1557	1698	1855	2106
60	291	323	358	397	442	490	543	615	682	763	866	952	1029	1111	1201	1223	1460	1595	1742	1900	2246
66	298	330	367	408	452	501	557	626	697	781	887	977	1054	1139	1231	1255	1500	1633	1782	2025	2394
72	305	342	377	419	462	513	570	643	714	798	911	998	1080	1166	1262	1283	1532	1674	1825	2160	2552
78	313	346	386	425	473	525	583	659	731	820	928	1022	1104	1192	1287	1315	1569	1712	1946	2303	2721
84	319	354	391	435	483	538	597	672	747	836	951	1047	1132	1219	1317	1344	1603	1750	2074	2454	2900
90	328	362	402	446	495	550	609	688	765	855	971	1069	1155	1270	1361	1374	1640	1865	2212	2615	3092
96	333	369	412	457	507	560	621	703	778	873	994	1094	1181	1325	1393	1403	1676	1988	2358	2788	3295
102	346	382	423	470	521	580	644	726	806	954	1087	1193	1290	1453	1520	1601	1912	2268	2690	3181	3760
108	350	390	432	478	533	590	655	740	822	975	1110	1218	1317	1461	1570	1707	2038	2418	2868	3391	4009
114	358	395	439	489	543	602	669	755	838	928	1059	1160	1256	1398	1508						
120	365	406	450	500	555	615	682	771	855	948	1077	1186	1281	1421	1566						
126	373	414	460	511	564	627	694	785	871	968	1100	1209	1309	1453	1586						
132	382	423	470	521	576	642	710	800	889	986	1121	1234	1333	1482							
138	390	430	477	531	588	654	725	818	907	1007	1144	1259	1361	1505							
144	395	438	486	542	599	667	739	833	924	1025	1166	1283	1389	1565							

Color Lux Linen Blackout: Minimum standard shade size is 12" x 12". Maximum shade width is 116" and it can be railroaded to a maximum width of 144" and a maximum length of 104"

Head Rail Options and Surcharges

Section 1 & 2	Available: Skyline Hardware (All), Designer Cassette (All), Cordless Deco-Bar, 4" Skyline Fascia, Motorization, PowerTouch Rechargeable
Section 3	Available: Skyline Roller Only with Cordloop, Heavy Duty Motorization (Roller Only), 4" Skyline Fascia with Cord Loop (Dual Roller Not Available)
Section 4	Available: Skyline Roller Only with Cordloop, and Heavy Duty Motorization (Roller Only) (Dual Roller Not Available)

Roller Only Options

Skyline Clutch (White, Ivory, Black)	No Additional Surcharge
Skyline Clutch (Satin Nickel and Bronze)	\$28
Skyline Dual Roller (Price two separate shades, then add surcharge)	\$28
Cordless with White, Ivory and Black Deco-Bar	\$42
Cordless with Bronze and Satin Nickel Deco-Bar	\$63
NEW FeatherTouch™ Cordless with EZ Mount Hardware in White and Black	\$42
NEW FeatherTouch™ Cordless with EZ Mount Hardware in Designer Nickel	\$63
Spring Assist for Shades over 84" x 84" (White or Black Clutch)	\$130
Scotchgard™ Stain Protection for Roller Shades	\$38

Cordless Specifications:
 Minimum width is 15½"; Maximum Width is 96";
 Maximum Length is 96"

FeatherTouch Cordless Specifications:
 Minimum width is 17"; If width is 26" or less, then
 maximum length is 51". If width is over 26", then
 maximum length is 84".

Designer Cassette and Fascia Options

	24	30	36	42	48	54	60	66	72	78	84	90	96	102	108	114	120
White, Ivory, Black, Satin Nickel, and Oil Rubbed Bronze Includes Smooth Face, Insert Strip and Fabric Wrap	78	84	90	97	103	111	119	126	133	128	135	147	152	156	162	185	208
4" Skyline Fascia	64	70	72	74	84	97	106	117	128	137	149	162	169	179	191	201	210
Cordless, FeatherTouch™ & Retractable Cord with Cassette	Add \$42 PLUS the Designer Cassette Surcharge for all operating options																

Highlights Cornice Valance

	24	30	36	42	48	54	60	66	72	78	84	94	96	102	108	114	120	132	144
6" & 8" Highlights Cornice Valance (No Keystone)	147	163	178	194	210	219	231	242	253	263	275	293	Requires Keystone. See pricing below						
6" & 8" Highlights Cornice Valance (with ONE Keystone)	198	214	230	244	261	271	282	295	303	315	326	345	349	360	370	381	393	409	419
10" - 16" Highlights Cornice Valance (No Keystone)	198	220	241	262	284	296	312	326	341	355	372	395	Requires Keystone. See pricing below						
10" - 16" Highlights Cornice Valance (with ONE Keystone)	267	289	311	329	352	366	381	398	409	425	441	465	471	486	500	515	530	552	566

Motorization: Available with Designer Cassette, 4" Skyline Fascia, and Standard Roller

Add Motorization surcharges to base shade price, plus desired hardware options		Reference
PowerTouch Rechargeable	\$118 per shade	pg. 93
Simplicity Wave	\$121 per shade	pg. 90
Simplicity Rechargeable & Non-Rechargeable Motorization	\$319 per shade	pg. 95
Simplicity Rechargeable Heavy Duty Motorization	\$434 per shade	pg. 96
Simplicity Low Voltage Hard Wired Transformer	\$74 per transformer	pg. 98
Simplicity 5 Channel Remote	\$41 per remote	pg. 100
Simplicity 6 Channel Timer Remote	\$67 per remote	pg. 100
Simplicity 14 Channel Remote	\$67 per remote	pg. 100
Simplicity Smart Controller	\$336 per controller	pg. 35
NEW EZ Charge Wand and Receiver	\$37/\$20 each	pg. 97
Solar Panel	\$105 per panel	pg. 96
Telescoping Wand for Simplicity Wave	\$32 per wand	pg. 90
Charger for Simplicity Rechargeable Motor	\$28 per charger	pg. 95
Charger for Heavy Duty Rechargeable Motor	\$59 per charger	pg. 96

- Tube Information for Clutch Operated Shades Only**
- Section 1:** Shades to the left of the dashed line requires a 1" tube/ SL10" clutch
 - Section 2:** Shades to the right of the dashed line requires a 1½" tube/ SL10 clutch
 - Section 3:** Shades in the blue section requires a 2" tube/SL20 clutch.
 - Section 4:** Shades in the orange section requires a 2½" tube/Galaxy 200 clutch

COLORLUX® ROLLER SHADES

Skyline Standard Roller Shade

Price Group 23 | Solar Screen 5

Length In Inches	Width In Inches																				
	24	30	36	42	48	54	60	66	72	78	84	90	96	102	106	112	118	124	130	136	144
36	236	262	291	323	359	397	442	498	553	620	706	777	837	905	976	998	1188	1297	1415	1547	1688
42	241	269	298	332	368	409	453	512	569	637	723	796	859	929	1003	1023	1220	1331	1456	1587	1736
48	249	276	307	342	379	421	465	525	584	653	743	818	883	953	1030	1049	1252	1366	1492	1630	1778
54	258	283	314	349	387	428	478	538	598	669	763	837	907	979	1057	1078	1284	1402	1530	1672	1826
60	262	291	323	358	397	441	490	553	615	687	780	858	927	1001	1081	1102	1315	1437	1570	1712	1846
66	269	297	331	366	408	452	501	564	627	703	798	881	949	1026	1108	1132	1349	1472	1606	1755	1871
72	274	306	337	378	417	462	513	580	644	720	820	899	974	1049	1136	1157	1381	1508	1644	1798	1899
78	282	312	348	384	425	473	525	593	657	739	837	920	995	1075	1159	1185	1413	1541	1683	1805	2063
84	288	319	353	391	436	485	538	604	674	753	857	944	1018	1100	1186	1211	1444	1577	1625	1810	2125
90	295	326	362	402	446	495	549	620	688	771	875	963	1041	1144	1224	1238	1476	1613	1661	1826	2189
96	300	333	369	413	456	505	560	634	701	787	895	985	1063	1192	1254	1265	1509	1647	1696	2036	2255
102	311	345	381	423	469	522	580	653	726	804	915	1006	1086	1223	1280	1302	1555	1696	1895	2097	2323
108	316	351	390	431	480	532	590	666	741	821	933	1026	1108	1231	1322	1341	1601	1747	1952	2160	2392
114	322	357	395	440	490	543	602	680	756	837	953	1046	1133	1260	1360						
120	329	365	406	450	500	554	615	693	771	854	971	1069	1154	1280	1411						
126	335	373	414	461	508	565	626	707	786	871	990	1089	1180	1309	1429						
132	345	381	423	469	520	579	640	721	801	889	1010	1111	1202	1335	1509						
138	351	388	430	478	529	589	652	735	818	907	1030	1134	1224	1356	1536						
144	357	394	438	489	539	600	664	750	833	922	1049	1156	1251	1410	1577						

Solar Screen 5: Minimum standard shade size is 12" x 12". Maximum shade width is 116" and it can be railroaded to a maximum width of 144" and a maximum length of 104".

Head Rail Options and Surcharges

Section 1 & 2	Available: Skyline Hardware (All), Designer Cassette (All), Cordless Deco-Bar, 4" Skyline Fascia, Motorization, PowerTouch Rechargeable
Section 3	Available: Skyline Roller Only with Cordloop, Heavy Duty Motorization (Roller Only), 4" Skyline Fascia with Cord Loop (Dual Roller Not Available)
Section 4	Available: Skyline Roller Only with Cordloop, and Heavy Duty Motorization (Roller Only) (Dual Roller Not Available)

Roller Only Options

Skyline Clutch (White, Ivory, Black)	No Additional Surcharge
Skyline Clutch (Satin Nickel and Bronze)	\$28
Skyline Dual Roller (Price two separate shades, then add surcharge)	\$28
Cordless with White, Ivory and Black Deco-Bar	\$42
Cordless with Bronze and Satin Nickel Deco-Bar	\$63
NEW FeatherTouch™ Cordless with EZ Mount Hardware in White and Black	\$42
NEW FeatherTouch™ Cordless with EZ Mount Hardware in Designer Nickel	\$63
Spring Assist for Shades over 84" x 84" (White or Black Clutch)	\$130
Scotchgard™ Stain Protection for Roller Shades	\$38

Cordless Specifications:
 Minimum width is 15½"; Maximum Width is 96";
 Maximum Length is 96"

FeatherTouch Cordless Specifications:
 Minimum width is 23"; If width is 36" or less, then maximum length is 63". If width is over 36", then maximum length is 84".

Designer Cassette and Fascia Options

	24	30	36	42	48	54	60	66	72	78	84	90	96	102	108	114	120
White, Ivory, Black, Satin Nickel, and Oil Rubbed Bronze Includes Smooth Face, Insert Strip	78	84	90	97	103	111	119	126	133	128	135	147	152	156	162	185	208
4" Skyline Fascia	64	70	72	74	84	97	106	117	128	137	149	162	169	179	191	201	210
Cordless, FeatherTouch™ & Retractable Cord with Cassette	Add \$42 PLUS the Designer Cassette Surcharge for all operating options																

Highlights Cornice Valance

	24	30	36	42	48	54	60	66	72	78	84	94	96	102	108	114	120	132	144
6" & 8" Highlights Cornice Valance (No Keystone)	147	163	178	194	210	219	231	242	253	263	275	293	Requires Keystone. See pricing below						
6" & 8" Highlights Cornice Valance (with ONE Keystone)	198	214	230	244	261	271	282	295	303	315	326	345	349	360	370	381	393	409	419
10" - 16" Highlights Cornice Valance (No Keystone)	198	220	241	262	284	296	312	326	341	355	372	395	Requires Keystone. See pricing below						
10" - 16" Highlights Cornice Valance (with ONE Keystone)	267	289	311	329	352	366	381	398	409	425	441	465	471	486	500	515	530	552	566

Motorization: Available with Designer Cassette, 4" Skyline Fascia, and Standard Roller

Add Motorization surcharges to base shade price, plus desired hardware options		Reference
PowerTouch Rechargeable	\$118 per shade	pg. 93
Simplicity Wave	\$121 per shade	pg. 90
Simplicity Rechargeable & Non-Rechargeable Motorization	\$319 per shade	pg. 95
Simplicity Rechargeable Heavy Duty Motorization	\$434 per shade	pg. 96
Simplicity Low Voltage Hard Wired Transformer	\$74 per transformer	pg. 98
Simplicity 5 Channel Remote	\$41 per remote	pg. 100
Simplicity 6 Channel Timer Remote	\$67 per remote	pg. 100
Simplicity 14 Channel Remote	\$67 per remote	pg. 100
Simplicity Smart Controller	\$336 per controller	pg. 35
NEW EZ Charge Wand and Receiver	\$37/\$20 each	pg. 97
Solar Panel	\$105 per panel	pg. 96
Telescoping Wand for Simplicity Wave	\$32 per wand	pg. 90
Charger for Simplicity Rechargeable Motor	\$28 per charger	pg. 95
Charger for Heavy Duty Rechargeable Motor	\$59 per charger	pg. 96

- Tube Information for Clutch Operated Shades Only**
- **Section 1:** Shades to the left of the dashed line requires a 1" tube/ SL10" clutch
 - **Section 2:** Shades to the right of the dashed line requires a 1½" tube/ SL10 clutch
 - **Section 3:** Shades in the blue section requires a 2" tube/SL20 clutch.
 - **Section 4:** Shades in the orange section requires a 2½" tube/Galaxy 200 clutch

SKYLINE STANDARD ROLLER HARDWARE SYSTEM

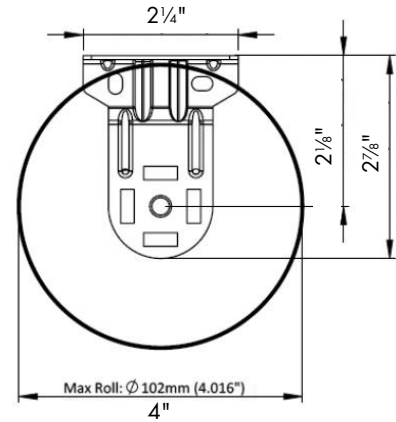
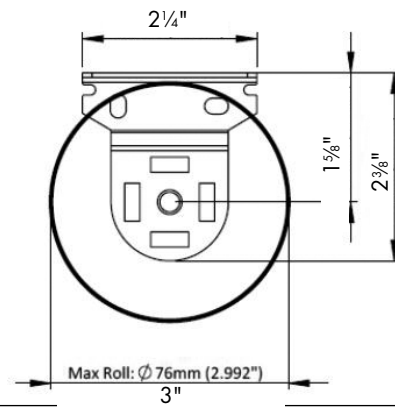

Hardware Features

Roll Style:	Standard or reverse (reverse roll information is found on page 80)
Bead Chain Color:	White, Black, Ivory, Satin Nickel and Bronze
Clutch Color:	White, Black, Ivory, Satin Nickel and Bronze
Bracket Cover Colors:	White, Black, Ivory, Satin Nickel and Bronze (Heavy Duty Motorization does not offer bracket covers)
Bracket Colors:	White, Black, Ivory and Bronze (Heavy Duty Motorization Brackets are white only)
Bottom Rail Style:	Fabric Wrapped or Exposed Bottom Rail
Bottom Rail Color:	Fabric Wrapped: White, Black, Ivory, Brushed Aluminum and Bronze Exposed: White, Black, Ivory, Brushed Aluminum and Bronze
Motorization	Skyline Standard Roller Hardware can be motorized with Simplicity Rechargeable Motorization and PowerTouch Rechargeable.

Mounting Dimensions

The standard 1" and 1 1/2" tubes are available with two brackets in 2 3/8" or 2 7/8" projection.

Minimum depth for flush inside or side mount including installation brackets: 2 1/4"

The oversized 2" tube is available with one bracket in a 2 7/8" projection.

Minimum depth for flush inside mount including installation brackets: 2 1/4"

Standard Roller Finished Dimensions	Standard Tube Cord Loop (1" & 1 1/2" diameter)	Standard Tube Motorized (1 1/2" diameter)	Oversized Tube Cord Loop (2" diameter)	Oversized Tube Cord Loop (2 1/2" diameter)	Oversized Tube Motorization (2" & 2 1/2" diameter)
Inside Mount (+/- 1/8")					
Bracket to Bracket:	Ordered width	Ordered width	Ordered width	Ordered width	Ordered width minus 3/16"
End to End Roller Width:	Ordered width minus 1"	Ordered width minus 1/16"	Ordered width minus 1 1/16"	Ordered width minus 1 1/4"	Ordered width minus 2 3/16"
Fabric Width:	Ordered width minus 1 1/16"	Ordered width minus 1 3/16"	Ordered width minus 1 1/8"	Ordered width minus 1 5/16"	Ordered width minus 2 1/4"
Bottom Rail Width:	Ordered width minus 1 1/16"	Ordered width minus 1 3/16"	Ordered width minus 1 1/8"	Ordered width minus 1 5/16"	Ordered width minus 2 1/4"
Outside Mount and Inside Mount with Bracket Covers (+/- 1/8")					
End Cap Cover to End Cap Cover:	Ordered width	Ordered width	Ordered width	Ordered width	N/A
Bracket to Bracket:	Ordered width minus 1/8"	Ordered width minus 1/4"	Ordered width minus 1/8"	Ordered width minus 1 1/8"	Ordered width minus 3/16"
End to End Roller Width:	Ordered width minus 1 1/8"	Ordered width minus 1 1/4"	Ordered width minus 1 3/16"	Ordered width minus 1 3/8"	Ordered width minus 1 13/16"
Fabric Width:	Ordered width minus 1 3/16"	Ordered width minus 1 5/16"	Ordered width minus 1 1/4"	Ordered width minus 1 7/16"	Ordered width minus 1 7/8"
Bottom Rail Width:	Ordered width minus 1 3/16"	Ordered width minus 1 5/16"	Ordered width minus 1 1/4"	Ordered width minus 1 7/16"	Ordered width minus 1 7/8"

G200 clutch and Skyline Spring Assist require an additional 1/8" deduction from Cordloop 2" diameter shades.

Color Lux® Roller Shades

SKYLINE CORD LOOP HARDWARE OPTIONS



Skyline Hardware in White



Skyline Hardware in Ivory



Skyline Hardware in Black



Skyline Hardware in Bronze



Skyline Hardware in Satin Nickel

COLORLUX® ROLLER SHADES

Tensioners for Cord Loop Shades

Cord Loop Roller Shades feature a new tensioner design for easy mounting and smooth operation. Available in five finishes that matches the clutch control on Skyline Cord Loop roller shades, now every part of a Skyline Roller shade will coordinate from top to bottom.



White Tensioner



Black Tensioner



Ivory Tensioner



Bronze Tensioner



Satin Nickel Tensioner

Color Lux Roller Shade Cord Loop Information

Color Lux Roller Shades are available with a choice of colored bead chain colors.

- Select white, black, bronze or steel bead chain with the Standard Roller, Fascia, and Designer Cassette head rail options.
- The bead chain will measure the length indicated below unless otherwise specified.

SHADE HEIGHT	LOOP DROP
12" to 15 ⁷ / ₈ "	² / ₃ of shade height
16" to 29 ⁷ / ₈ "	³ / ₄ of shade height
30" - 35 ⁷ / ₈ "	24" Loop
36" - 41 ⁷ / ₈ "	30" Loop
42" - 47 ⁷ / ₈ "	36" Loop
48" - 53 ⁷ / ₈ "	42" Loop
54" - 59 ⁷ / ₈ "	48" Loop
60" - 65 ⁷ / ₈ "	54" Loop
66" - 71 ⁷ / ₈ "	60" Loop
72" - 77 ⁷ / ₈ "	66" Loop
78" - 89 ⁷ / ₈ "	72" Loop
90" - 101 ⁷ / ₈ "	84" Loop
102" - 113 ⁷ / ₈ "	96" Loop
114" - above	³ / ₄ of shade height

- Bead chain can be ordered in custom lengths. Maximum bead chain length is 15 feet.

Color Lux® Roller Shades
CORDLESS ROLLER WITH DECO-BAR HARDWARE SYSTEM



Shades Measuring 15½" to 72":

- A = 1½"
- B = 1⅝"
- C = 2¼"
- D = 1¼" Roller

Shades Measuring 72" to Maximum Width:

- A = 1¾"
- B = 1¾"
- C = 2¾"
- D = 1½" Roller

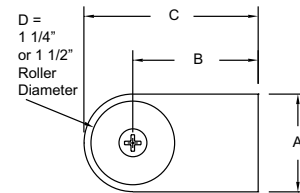
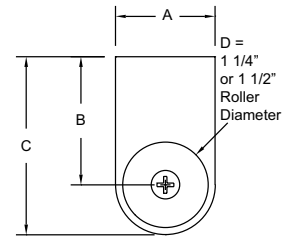

COLORLUX® ROLLER SHADES

Head Rail Consistency

Fabric will add an average of ⅛" to the diameter of the tube for every 10" of fabric rolled onto the tube. Contact Technical Services if additional services is needed.

Hardware Features

Roll Style:	Standard or reverse (reverse roll information is found on page 80)
Hardware Color:	White, Ivory, Black, Satin Nickel and Bronze (brackets are white or black)
Bracket Covers:	White, Ivory, Black, Satin Nickel and Bronze
Bottom Rail Style:	Fabric Wrapped or Exposed Bottom Rail
Bottom Rail Color:	Fabric Wrapped: White, vanilla, bronze, black or brushed aluminum Exposed: White, vanilla, bronze, black or brushed aluminum
Motorization	Cordless Roller with Deco-Bar cannot be motorized.
Head Rail Surcharge	See price grids for Cordless surcharge information.

Mounting Dimensions

- Minimum depth for flush inside mount including installation brackets: 1¾"
- Minimum inside mounting height: 1¼"
- Minimum outside mounting height: 1"

Cordless Roller with Deco-Bar Finished Dimensions (+/- ⅛")

Inside Mount

Head Rail Measurement:	Ordered width minus ⅜" (measurement includes end brackets)
Fabric Width:	Ordered width minus 1⅜"

Inside Mount with Bracket Covers

Head Rail Measurement:	Ordered width minus 7/16"
Fabric Width:	Ordered width minus 1 1/16"

Outside Mount

Head Rail Measurement:	Ordered width plus ⅜" (measurement includes end brackets)
Fabric Width:	Ordered width minus 7/16"

Side Mount

Head Rail Measurement:	Ordered width minus 1 1/16" (measurement includes end brackets)
Fabric Width:	Ordered width minus 1 5/16"

Exact End to End Mount

Head Rail Measurement:	Ordered width (measurement includes end brackets)
Fabric Width:	Ordered width minus 5/8"

Cordless Roller Shades with Designer Cassette

Create a sleek look with the Designer Cassette Head Rail. Available in White, Ivory, Black, Satin Nickel and Bronze. See individual fabric specifications for minimum and maximum shade sizes. Cordless Roller Shades with Designer Cassette are available with the Smooth Face, Fabric Insert or Fabric Wrapped options.

See page 92 for the five Designer Cassette colors.

Cordless Roller DecoBar

This cord-free system operates like a spring roller shade with a gentle tug on the bottom rail to raise and lower the shade. See page 80 for mounting information and finished dimension information. Reverse roll is available for the Deco-Bar Cordless option



White Cordless Roller Deco-Bar



Black Cordless Roller Deco-Bar



Ivory Cordless Roller Deco-Bar



Bronze Cordless Roller Deco-Bar



Satin Nickel Cordless Roller Deco-Bar

NEW Cordless Roller DecoBar Standard Light Block

All Color Lux Roller Decobar shades now feature a standard light block behind the rail for enhanced light control between the rail and the fabric roll. The light block is always white to the room side and is a no charge feature exclusively for Color Lux Cordless DecoBar roller shades.

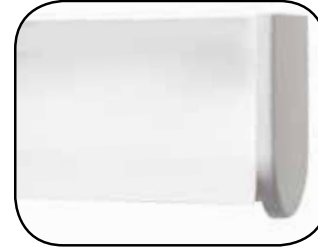

Standard Light Block

NEW Cordless Roller DecoBar Fabric Valance

All ColorLux Cordless DecoBar shades now feature a beautiful fabric valance option. This option is perfect to conceal the roll of the cordless decobar system but still maintain the 1 3/4" for shallow applications.

Dealer List Price = \$33.00

The fabric valance is available on Linen Light Filtering, Linen Blackout, Duck Light Filtering and Duck Blackout and Solar Screen 5 fabric. The valance will always match the shade pattern and fabric.

All valances are 4.5" long to ensure that the roll and bottom rail is concealed when the shade is raised.

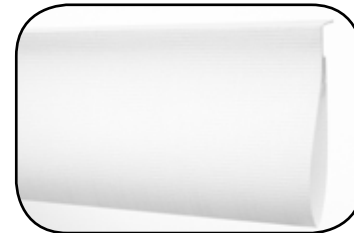

Fabric Valance Upgrade

Cordless Roller Deco-Bar Bracket Covers

The Cordless Roller Decobar now offers deco bar covers in White, Ivory, Black, Satin Nickel and Bronze that coordinates with the deco-bar color selected. Available for Inside Mount or Outside Mount applications. Brackets are White and Black only.



Bracket cover provides a clean finished appearance

COLORLUX® ROLLER SHADES

Color Lux® Roller Shades

CORDLESS OPERATION

Cordless Tassels and Pulls

Add a decorative tassel or pull to help facilitate easy operation and keep the fabric on the bottom rail clean on all Cordless Shades. Tassels and pulls are placed in the middle of the bottom rail. They feature an approximately 3-inch long cord which coordinates with the tassel color.

Tassels and pulls are attached to the back of the bottom rail with a clear clip. This allows for in the field modifications if needed.

ALL Color Lux Roller Shade hardware is available with any Tassel or Pull.

Wood Ball Pulls

Add a decorative Wood Ball Pull to help facilitate easy operation and keep the fabric on the bottom rail clean on all Color Lux Roller Shades. Select from 4 colors: Waxed, Natural, Whitewash and Cocoa.

Add: \$18 Per Shade

Beehive Pulls

Add a durable and fashionable Beehive Pull to your shades for easy lifting and lowering. These are a great combination with solar shades and are available in White and Onyx. The Beehive pull is 2 5/8" long.

Add: \$42 Per Shade

Wood Tassels

Select from 5 colors: Milky White, Ebony, Walnut, Light Pine or Mahogany. A wood tassel is 1 5/8" long.

Add \$18 Per Shade

Jute Ball

Add a simple and natural accent to any cordless roller shade with the Jute Ball Pull. Available in a single Jute color.

Add: \$18 Per Shade

Droplet Pull

Wound with soft yarn in a elegant shape that fits comfortably into the palm of your hand. Available in Navy, Grey, Ivory and Clay. See the 2019 Envision Designer Collection Sample book for full color offering.

The Pear pull is 2 1/8" long.

Add: \$42 Per Shade

Clear Handle for Cordless Roller Shades

A clear handle comes included with all cordless roller shade orders with an option to attach the handle during installation. This easy to attach and easy to remove clear handle is a great way to keep the rail or the fabric (for fabric wrapped option) clean and new after regular shade use. The width of the handle is 2 1/8" wide.



Optional Clear Handle



Cocoa

Whitewash

Waxed

Natural



Onyx

White



Grey

Navy

Clay

Ivory

Reverse Roll on Color Lux Roller Shades

A reverse roll option is available at no extra charge with all Color Lux Roller Shade fabrics only on the Standard Roller Hardware and Cordless Roller with Deco-Bar Hardware. The reverse roll allows the fabric to roll off the front of the roller instead of the back (the traditional style). The reverse roll conceals the roller for a contemporary, tailored appearance.



White Cordless Roller with Deco-Bar in Standard Roll



Black Cordless Roller with Deco-Bar in Standard Roll



White Cordless Roller with Deco-Bar in Reverse Roll



Black Cordless Roller with Deco-Bar in Reverse Roll



Standard Roller in Standard Roll



Standard Roller in Reverse Roll

Bottom Rail Options

Color Lux Roller Shades can be built with your choice of 2 bottom rail options:

- Fabric Wrapped Bottom Rail (standard)
- Exposed Bottom Rail

Choose your bottom rail color when ordering.

Fabric Wrapped Bottom Rail

The shade fabric is wrapped around an elliptical grooved rail. Two clear plastic end caps secure the fabric in place. Select from bronze, white, vanilla, black or brushed aluminum.

Choose your bottom rail color when ordering.



Fabric Wrapped Bottom Rail

Exposed Bottom Rail

Select from bronze, white, vanilla, black or brushed aluminum bottom rail to add a decorative accent to the bottom of your shade. Two clear plastic end caps secure the fabric in place.

Choose your bottom rail color when ordering.



Bronze Exposed Bottom Rail

Spring Assist for Skyline Roller Shades

Spring assist is a great option for larger shades that reduces the pull force of clutch operated shades by up to 40%.

Spring Assist is available for standard roller shades, 4" Skyline Fascia and Designer Cassette.



Spring Assist is not available for motors or cordless shades.

Spring Assist is only available with a White or Black Skyline Clutch. Other Skyline Designer colors are not available.

Spring assist is recommended for shades 84" x 84" or larger. Minimum shade width is 60".

See page 75 for deduction information.

Add \$130 List to standard rectangular shade.

Color Lux® Roller Shades

NEW FEATHERTOUCH™ CORDLESS WITH EZ MOUNT HARDWARE



Shade Bracket Dimensions:

- A = 2½"
- B = 2¾"
- C = 3¼"
- D = 1½" Diameter (37mm)

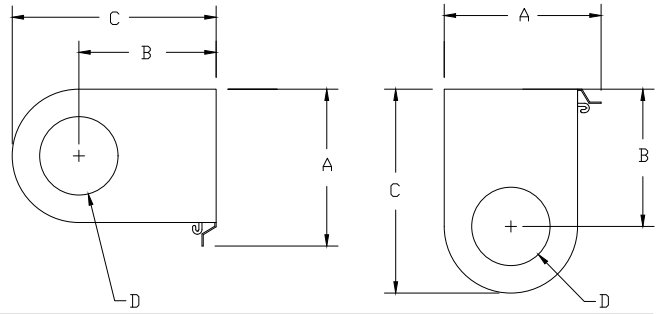

Head Rail Consistency

Fabric will add an average of 1/8" to the diameter of the tube for every 10" of fabric rolled onto the tube. Contact Technical Services if additional services is needed.

Hardware Features

Roll Style:	Standard roll only (Reverse roll is not available)
EZ Mount Hardware Color:	White, Black and Nickel
Bracket Covers:	White, Black and Nickel
Bottom Rail Style:	Fabric Wrapped or Exposed Bottom Rail
Bottom Rail Color:	Fabric Wrapped: White, vanilla, bronze, black or brushed aluminum Exposed: White, vanilla, bronze, black or brushed aluminum
Motorization	FeatherTouch Roller with EZ Mount hardware cannot be motorized.
Head Rail Surcharge	See price grids for Cordless surcharge in a Designer Cassette.

Mounting Dimensions

- Minimum depth for flush inside mount including installation brackets: 2½"
- Minimum outside mounting height: 2¼" (1/8" below bracket and 5/8" minimum above bracket)

FeatherTouch Cordless Roller Finished Dimensions (+/- 1/8")

Inside Mount with EZ Mount Hardware		Inside Mount with Designer Cassette
Head Rail Measurement:	Ordered width minus 3/16" (includes end brackets & covers)	Ordered width minus 3/16" (includes end caps)
Fabric Width:	Ordered width minus 1 3/16"	Ordered width minus 1 ¼"
Outside Mount with EZ Mount Hardware		Outside Mount with Designer Cassette
Head Rail Measurement:	Ordered width plus ½" (includes end brackets and covers)	Ordered width plus 3/16" (includes end caps)
Fabric Width:	Ordered width minus ½"	Ordered width minus 7/8"
Exact End to End Mount with EZ Mount Hardware		Exact Mount with Designer Cassette
Head Rail Measurement:	Ordered width (includes end brackets and covers)	Ordered width (includes end caps)
Fabric Width:	Ordered width minus 1"	Ordered width minus 1 1/16"

FeatherTouch Size Specifications:

Fabric	Minimum Width	Size Specification Chart (Minimum Length = 15" for all fabrics)
Linen Light Filtering	20"	If width is 30" or less, then maximum length is 57". If width is over 30", then maximum length is 84".
Linen Blackout	17"	If width is 26" or less, then maximum length is 51". If width is over 26", then maximum length is 84".
Duck Light Filtering	19"	If width is 30" or less, then maximum length is 61". If width is over 30", then maximum length is 84".
Duck Blackout	17"	If width is 26" or less, then maximum length is 53". If width is over 26", then maximum length is 84".
Solar Screen 5	23"	If width is 36" or less, then maximum length is 63". If width is over 36", then maximum length is 84".

Color Lux® Roller Shades

NEW FEATHERTOUCH™ CORDLESS GENERAL INFORMATION

FeatherTouch™ Cordless Features

Unlike other spring operated cordless shades, the FeatherTouch™ cordless roller system maintains a balance between the weight of the fabric and the strength of the spring. This provides:

- Fine adjustment and precision placement of the shade
- Alignment across multiple shades
- Safest option for kids
- Smooth operation
- All EZ Mount hardware shades feature a standard light block
- FeatherTouch is NOT available on Custom Graphics 5% Screen fabric.

List Price for FeatherTouch Cordless Upgrade Option: \$42.00



EZ Mount Hardware ensures the proper spacing of brackets for the best performance.

FeatherTouch™ Operation

To operate FeatherTouch Cordless shades, simply pull on the center of the bottom rail until you reach your desired position. To lift your shade, push the bottom rail upwards. FeatherTouch does not have an release mechanism that raises the shade. Operation is all with a touch of your finger.



A light block is standard with every EZ Mount shade

FeatherTouch™ EZ Mount Hardware Finishes

FeatherTouch is available with the EZ Mount Hardware option or Designer Cassette.

EZ Mount hardware is available in three colors:

- White
- Black
- Designer Nickel (**\$63.00 List Surcharge**)

All FeatherTouch shades with EZ Mount hardware includes matching end cap covers for both inside mount and outside mount shades.



White EZ Mount Hardware



Black EZ Mount Hardware



Designer Nickel EZ Mount Hardware



Designer Cassette (All Options)

COLORLUX® ROLLER SHADES

FeatherTouch™ Cordless Options and Upgrades

Fabric Valance Option for Inside Mount Shades

FeatherTouch Cordless Shades feature an optional 4.5" fabric valance to conceal the EZ Mount Hardware. Valances are only available in matching shade fabric and color, and attach separately with the supplied brackets. A light block is attached to the back of the head rail for better light control. Fabric Valances are only available for Inside Mount shades ordered with the EZ Mount Hardware system. A surcharge of **\$33.00 List** will apply.



Fabric Valance Upgrade

Clear Handle

A clear handle is included at no charge for every FeatherTouch roller shade unit. To prevent damage to the roller shade fabric, handles are not installed at the factory. The width of the handle is 2 1/8" wide.

Telescoping: To prevent telescoping, the factory has indicated the center of your bottom rail for easy and accurate handle placement.



Clear Handle

Magnetic Wand Kit

The magnetic wand is optional for hard to reach shades and attaches to the magnetic plate included with your kit. Four handle plates are included with every kit. The pole is extendable up to 33". A surcharge of **\$39 List** will be applied. Other standard pole options are available.



Optional Magnetic Wand Kit

Additional Information

- FeatherTouch Cordless is NOT available as reverse roll.
- Decorative Pulls and Tassels are NOT available.
- A 6mm hex wrench is required if adjustment is necessary. Tension and upstops are set at the factory.

DESIGNER CASSETTE WITH INSERT STRIP HARDWARE SYSTEM



Insert Strip



Fabric Wrap



Smooth Face

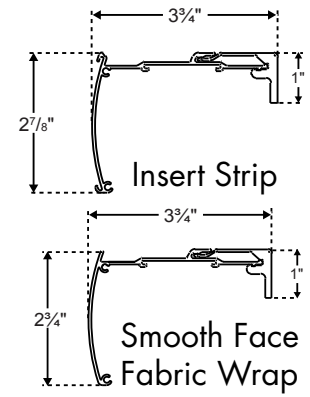

COLORLUX® ROLLER SHADES

Hardware Features

Roll Style:	Standard only
Head Rail Color:	White, Ivory, Black, Satin Nickel and Bronze with matching fabric insert strip Skyline Clutch is available in White, Ivory, Black, Satin Nickel and Bronze
Bottom Rail Style:	Fabric Wrapped or Exposed Bottom Rail
Bottom Rail Color:	Fabric Wrapped: White, vanilla, bronze, black or brushed aluminum Exposed: White, vanilla, bronze, black or brushed aluminum
Bead Chain Color:	White, ivory, black, bronze or steel bead chain
Operation Options:	Cord Loop: Select bead chain color, bottom rail style and color Cordless: Select bottom rail style and color
Motorization	Designer Cassette can be motorized with Simplicity Rechargeable Motorization and PowerTouch Rechargeable. See pages 99 - 100 for more details.

Mounting Dimensions

Minimum depth for flush inside mount including installation brackets: 3 3/4"
Minimum depth required for shallow mounting: 1"
Minimum depth for side mount: 1 1/8" • Maximum shade width for side mount: 48"
Minimum height required for outside mounting: 1"

Designer Cassette Finished Head Rail Measurements for Cord Loop, Cordless and Motorized Shades (+/- 1/8")

Inside Mount	
Head Rail Measurement:	Ordered width minus 3/16" (measurement includes end caps)
Outside Mount	
Head Rail Measurement:	Ordered width plus 3/16" (measurement includes end caps)
Side Mount	
Head Rail Measurement:	Ordered width minus 1 1/16" (measurement includes end caps)
Exact End to End Mount	
Head Rail Measurement:	Ordered width (measurement includes end caps)

Designer Cassette Finished Fabric Measurements (+/- 1/8")

Mount	Simplicity Motorization	Cordless	Skyline Cord Loop	NEW FeatherTouch™
Inside Mount:	Ordered width minus 1 1/16"	Ordered width minus 1"	Ordered width minus 1 1/4"	Ordered width minus 1 1/2"
Outside Mount:	Ordered width minus 1 1/16"	Ordered width minus 5/8"	Ordered width minus 7/8"	Ordered width minus 1 1/8"
Side Mount:	Ordered width minus 1 9/16"	Ordered width minus 1 1/2"	Ordered width minus 1 3/4"	N/A
Exact End to End Mount:	Ordered width minus 7/8"	Ordered width minus 1 3/16"	Ordered width minus 1 1/16"	Ordered width minus 1 5/16"

Color Lux® Roller Shades

TWO-ON-ONE HEAD RAIL SYSTEM

Two on One Head Rail roller shades are two roller shades sharing the same head rail; each roller operates independently.

Operating Options

- Two on One Head Rail can be combined with cord loop, PowerTouch Motorization, Simplicity Motorization and Simplicity Rechargeable Motorization hardware options.
- Controls will always be placed to the far left and far right. (Controls are NOT available between two shades)

Fabric Options

- Two on One Head Rail roller shades are available in all Color Lux Roller Shade fabrics.
- See price grids for standard size limitations.



Two-on-One No Head Rail Shades

The Two-on-One No Head Rail mounting option uses an intermediate bracket that reduces the light gap when two shades are placed side-by-side.

Cord Loop shades will always have the clutch on the outside of both shades to ensure proper tensioner mounting.

Standard Brackets are available in White, Black, Ivory and Bronze. Intermediate Brackets are available in White, Black and Ivory.

Bracket covers for the two outer shades are the same colors available for a Skyline Standard Roller Shade: White, Black, Ivory, Bronze and Satin Nickel.

Two-on-One No Head Rail Shades are available with Cord Loop, Simplicity Motorization, Simplicity Rechargeable Motorization and PowerTouch Rechargeable shades.

PowerTouch Rechargeable wands will always hang to the outside of each Two-on-One No Head Rail shade.

Head Rail Options

- Available with Designer Cassette or Standard Roller Shades.
- Two on One roller shades are ONLY available on 1½" tube.
- Available with Designer Cassette with Insert Strip and Smooth Face options.
- Fabric wrapping is NOT available on two on one Designer Cassette.
- Minimum single section is 12".
- Maximum width for a single section is 106".
- Total maximum width in Designer Cassette head rail is 140". Maximum shade sizes will vary by fabric
- Center gap between roller shades is ⅜".

TWO ON ONE CASSETTE PRICING EXAMPLE:

36" x 60" Classic Duck	
Blackout Fabric	\$358 x 2 = \$712
Designer Cassette Insert Strip	\$90 x 2 = \$180
PowerTouch Motorization:	\$118 x 2 = \$236

TOTAL LIST PRICE BEFORE DEALER DISCOUNT = \$1,128

- Specify shade total width and the two individual section widths. **Please Note:** The two individual sections must add up to the total width.

TWO ON ONE NO CASSETTE PRICING EXAMPLE:

For Satin Nickel Two-on-One No Head Rail Shades with PowerTouch Rechargeable:

36 x 60 Linen Light Filtering Fabric:	\$323 x 2 = \$646
Add Satin Nickel Skyline:	\$28 x 2 = \$56
Add PowerTouch Rechargeable:	\$118 x 2 = \$236

TOTAL LIST PRICE BEFORE DEALER DISCOUNT = \$938

Color Lux® Roller Shades

DUAL ROLLER WITH CORDLOOP & SIMPLICITY RECHARGEABLE MOTORIZATION

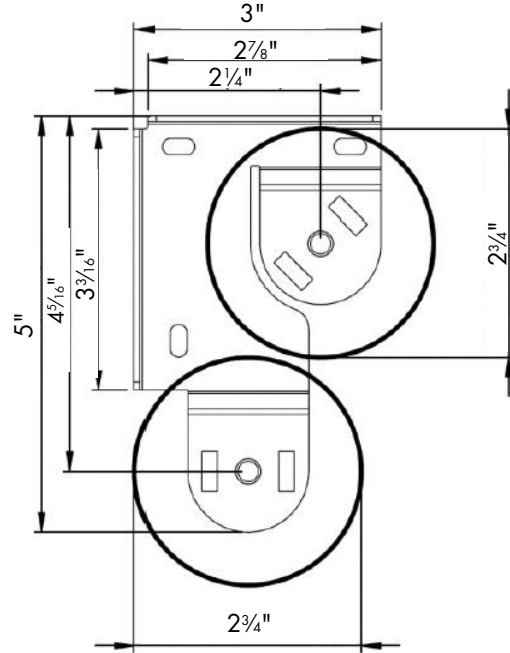

COLORLUX® ROLLER SHADES

Hardware Features	
Roll Style:	Standard and reverse roll is required (reverse roll information is found on page 72)
Bead Chain Color:	White, Ivory, Black, Satin Nickel and Bronze
Clutch Color:	White, Ivory, Black, Satin Nickel and Bronze (Skyline Hardware Only)
Bracket Cover Colors:	Bracket Covers are Not Available
Bracket Colors:	White and Black
Bottom Rail Style:	Fabric Wrapped or Exposed Bottom Rail
Bottom Rail Color:	Fabric Wrapped: White, Black, Ivory, Brushed Aluminum and Bronze Exposed: White, Black, Ivory, Brushed Aluminum and Bronze
Tensioner Colors:	White, Ivory, Black, Satin Nickel and Bronze
Motorization	Dual Roller Shade Hardware can be motorized with Simplicity Rechargeable Motorization. PowerTouch Rechargeable is not available. See page 99 - 100 for motorization details.

Mounting Dimensions	
Minimum depth for flush inside mount including installation brackets: 3"	
Minimum depth required for side mounting: 1"	

Standard Roller Finished Dimensions (+/- 1/8")	Standard Tube (1" and 1 1/2" diameter)	Oversized Tube (2" diameter)
Inside Mount and Outside Mount		
Bracket to Bracket Measurement:	Ordered width	Ordered width
End to End Roller Width:	Ordered width minus 1"	Ordered width minus 1 1/16"
Fabric Width:	Ordered width minus 1 1/16"	Ordered width minus 1 1/8"
Bottom Rail Width:	Ordered width minus 1 1/16"	Ordered width minus 1 1/8"

Color Lux® Roller Shades

DUAL ROLLER HARDWARE SYSTEM

Dual Roller Shades are available with Skyline Cord Loop and Simplicity Rechargeable Motorization. They are the perfect way to combine both light filtering and blackout fabrics into a single shade for the ultimate light control. Any fabric or screen in the Envision Designer Collection can be mixed and matched to create a versatile window for any time of day.

The front roll of fabric is always a reverse roll. The back roll of fabric is always a standard roll. Clutches are always on opposite sides of the shade to ensure a location for tensioner mounting.

Dual Roller Shades are not available with cordless operation or PowerTouch Rechargeable motorization. Bracket covers are available in white or black for outside mount shades only. Brackets are available in black and white.

Candeling will occur between the upper and lower fabric rolls if a Blackout fabric is selected as the back roll. This allows light to come through. Blackout fabric can be selected for the front roll to prevent this.

Simplicity Rechargeable Motorization is available with Dual Roller Shades to ensure easy installation without the need to mount two battery wands.

See price grids for Dual Roller Shade Specifications. Shade minimums and maximums are identical to single shade systems. Not available with 2" tube.

A **Highlights Valance** is the perfect option to conceal both roller tubes on a Dual Roller Shade system. Highlights Valances are available in 6", 8", 10", 12", 14" and 16" heights. See page 101 for details.

	Width In Inches																								
	24	30	36	42	48	54	60	66	72	78	84	94	96	102	108	114	120	132	144	156	168	180	192	204	216
6" & 8" Highlights Cornice Valance NO Keystone	147	163	178	194	210	219	231	242	253	263	275	293	Not Available. See One Keystone Option.												
6" & 8" Highlights Cornice Valance with ONE Keystone	198	214	230	244	261	271	282	295	303	315	326	345	349	360	370	381	393	409	419	431	445	457	Not Available. See Two Keystones		
6" & 8" Highlights Cornice Valance with TWO Keystones	Two Keystones are not available unless required due to fabric width.																		470	483	496	509	522	537	552



Candeling when Blackout Fabric is selected as the back roll.



Tensioners are mounted on opposite side of a Dual Roller Shade



Distance between rollers when front shade is raised all the way

DUAL ROLLER SHADE PRICING EXAMPLE:

For Satin Nickel Dual Roller Shades:
 Front Shade 36 x 60 Linen Light Filtering: \$323
 Back Shade 36 x 60 Linen Blackout: \$358
 Satin Nickel Skyline Clutch Surcharge: \$28 x 2 = \$56
 Add Dual Roller Shade Surcharge: \$28
TOTAL LIST PRICE BEFORE DEALER DISCOUNT = \$765

DESIGNER CASSETTE WITH RETRACTABLE CORD HARDWARE SYSTEM

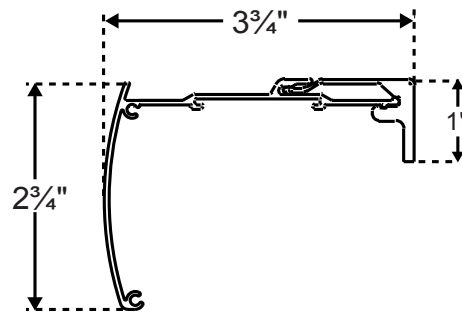

COLORLUX® ROLLER SHADES

Hardware Features

Roll Style:	Standard only
Head Rail Color:	White, Ivory, Black, Satin Nickel and Bronze Retractable Cord Clutch is available in White and Black only
Bottom Rail Style:	Fabric Wrapped or Exposed Bottom Rail
Bottom Rail Color:	Fabric Wrapped: White, vanilla, bronze, black or brushed aluminum Exposed: White, vanilla, bronze, black or brushed aluminum
Cord Color:	White or Black Cord and Tassel to coordinate with clutch

Cassette Surcharge See price grids for surcharge information.

Mounting Dimensions

Minimum depth for flush inside mount including installation brackets: 3 3/4"
Minimum depth required for shallow mounting: 1"
Minimum depth for side mount: 1 1/8" • Maximum shade width for side mount: 48"
Minimum height required for outside mounting: 1"

Designer Cassette Finished Head Rail Measurements for Retractable Cord (+/- 1/8")

Inside Mount	
Head Rail Measurement:	Ordered width minus 3/16" (measurement includes end caps)
Outside Mount	
Head Rail Measurement:	Ordered width plus 3/16" (measurement includes end caps)
Side Mount	
Head Rail Measurement:	Ordered width minus 1 1/16" (measurement includes end caps)
Exact End to End Mount	
Head Rail Measurement:	Ordered width (measurement includes end caps)

Designer Cassette Finished Fabric Measurements (+/- 1/8")

Mount	Retractable Cord
Inside Mount:	Ordered width minus 1 7/16"
Outside Mount:	Ordered width minus 1 1/16"
Side Mount:	Ordered width minus 1 15/16"
Exact End to End Mount:	Ordered width minus 1 1/4"

Color Lux® Roller Shades

DESIGNER CASSETTE WITH RETRACTABLE CORD HARDWARE SYSTEM

The Retractable Cord system for Color Lux Roller Shades is a perfect option for hard to reach shades when a continuous loop is not desired. The retractable cord system features smooth and easy to use operation. The Designer Cassette option is required for all Retractable Cord shades.

Colors

Clutch: is available in White or Black. Can be coordinated with any Designer Cassette option.

Cords and Tassels: White or Black

Operation

The clutch can be ordered to the right or left of the shade so the pull cord is easy to reach.

To raise, simply pull the cord straight down until it reaches full extension and then allow the cord to retract completely into the head rail. Each stroke partially raises the shade. The shade can be stopped at any point while raising.

To lower, simply pull the cord out towards you until it reaches full extension and then allow the cord to retract completely into the head rail. Each stroke partially lowers the shade. The shade can be stopped at any point while lowering.

Light Gap

Please note that there is a 3/4" light gap on the operation side of all roller shades.

Minimum ordered width for Retractable Cord shades is 12". See fabric specification pages for maximum sizes.

Cord Length

All retractable cord shades have a default cord length that is 40% of the total length. Custom options are available when ordering.



3/4" light gap on operation side. Clutches are available in white and black with tassels and cords in white or black

COLORLUX® ROLLER SHADES

Color Lux Retractable Cord Pricing Example:	
36 x 60 Linen Light Filtering Fabric:	\$323
Add Retractable Cord Surcharge:	\$42
TOTAL LIST PRICE BEFORE DEALER DISCOUNT = \$365	

DESIGNER CASSETTE WITH SIMPLICITY WAVE HARDWARE SYSTEM

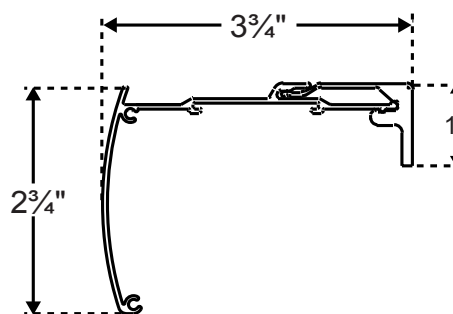

COLORLUX® ROLLER SHADES

Hardware Features

Roll Style:	Standard only
Head Rail Color:	White, Ivory, Black, Satin Nickel and Bronze Simplicity Wave is available with smooth face, fabric wrapped and insert strip Designer Cassette
Bottom Rail Style:	Fabric Wrapped or Exposed Bottom Rail
Bottom Rail Color:	Fabric Wrapped: White, vanilla, bronze, black or brushed aluminum Exposed: White, vanilla, bronze, black or brushed aluminum
Bead Chain Color:	White, black, bronze or steel bead chain
Motorization	See page 90 for pricing and more information on Simplicity Wave Motorization.
Cassette Surcharge	See price grids for surcharge information.

Mounting Dimensions

Minimum depth for flush inside mount including installation brackets: 3 3/4"
Minimum depth required for shallow mounting: 1"
Minimum depth for side mount: 1 1/8" • Maximum shade width for side mount: 48"
Minimum height required for outside mounting: 1"

Designer Cassette Finished Head Rail Measurements for Cord Loop, Cordless and Motorized Shades (+/- 1/8")

Inside Mount

Head Rail Measurement:	Ordered width minus 3/16" (measurement includes end caps)
------------------------	---

Outside Mount

Head Rail Measurement:	Ordered width plus 3/16" (measurement includes end caps)
------------------------	--

Side Mount

Head Rail Measurement:	Ordered width minus 1 1/16" (measurement includes end caps)
------------------------	---

Exact End to End Mount

Head Rail Measurement:	Ordered width (measurement includes end caps)
------------------------	---

Designer Cassette Finished Fabric Measurements (+/- 1/8")

Mount	Simplicity Wave Motorization
Inside Mount:	Ordered width minus 1 1/16"
Outside Mount:	Ordered width minus 1 1/16"
Side Mount:	Ordered width minus 1 9/16"
Exact End to End Mount:	Ordered width minus 7/8"

Color Lux® Roller Shades

DESIGNER CASSETTE WITH SIMPLICITY RECHARGEABLE ROLLER WAVE _____

Simplicity Rechargeable Roller Wave

The Simplicity Wave Motor features a roller motor with integrated batteries. Simplicity Wave requires a Designer Cassette option and uses a telescoping wand to raise or lower the shade.

The Simplicity Rechargeable Roller Wave option is available in all sizes in Section 1 of each fabric price grid.

Please Note:

- Not all motors run at the same rate of speed.
- Simplicity Rechargeable Roller Wave shades are programmed at the factory with the "up" and "down" limits.
- Order at least one charger.

Telescoping Wand

- Extends to 33" for hard to reach shades.
- Wand retracts to 9" for easy storage.
- Wand is silver with white handle and white magnetic tip.
- Wall mount plate included for convenience.
- Wand is universal and will operate all Simplicity Wave shades.



Battery Charger

8.4 Volt charger requires a standard power outlet to recharge the battery integrated within the motor. Must specify charger when ordering a PowerTouch Rechargeable shade. The charger plugs into the charger port. The charger is black and comes with a 156" (13') wire.



Mounting Requirements for Simplicity Rechargeable Wave with Designer Cassette

No special installation hardware or wiring requirements are needed to install Simplicity Wave Roller Shades with Designer Cassette Head Rail. A battery wand is not required.



Simplicity Wave for Roller Shades

Standard Color Lux Discounts apply to motorized lift systems pricing.

Motor

- Radio Frequency Motor \$121.00
Includes integrated rechargeable battery

Simplicity Wave Wand

- Telescoping Wand \$32.00

Simplicity Rechargeable Motor Battery Charger

- Charger for rechargeable motors (required): \$28.00

4" SKYLINE FASCIA WITH CORD LOOP AND SIMPLICITY MOTORIZATION

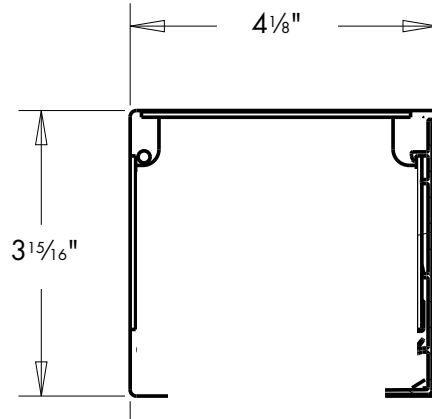

COLORLUX® ROLLER SHADES

Hardware Features

Fascia Colors:	White, Ivory, Black, Satin Nickel and Bronze
Roll Style:	Standard only
Bead Cord Style and Color:	White, Ivory, Black, Satin Nickel and Bronze
Skyline Clutch Colors:	White, Ivory, Black, Satin Nickel and Bronze
Bottom Rail Style:	Fabric Wrapped or Exposed Bottom Rail
Bottom Rail Color:	Fabric Wrapped: White, Black, Vanilla, Brushed Aluminum and Bronze Exposed: White, Black, Vanilla, Brushed Aluminum and Bronze
Tensioner Color:	White, Ivory, Black, Satin Nickel and Bronze
Motorization	4" Skyline Fascia can be motorized with Simplicity Rechargeable Motorization or PowerTouch™ Rechargeable. See grids for pricing and pages 93 - 100 for motorization details.

Mounting Dimensions

Minimum depth for flush inside mount including installation brackets: 4 1/8"
Minimum surface height required for outside mount: 4"
4" Inch Skyline Fascia can be installed as an inside mount with bracket covers.

Standard Roller Finished Dimensions (+/- 1/8")	Standard Tube (1" and 1 1/2" diameter)	Oversized Tube (2" diameter)
Inside Mount		
Bracket to Bracket Measurement:	Ordered width	Ordered width
End to End Roller Width:	Ordered width minus 1"	Ordered width minus 1 1/16"
Fabric Width:	Ordered width minus 1 1/16"	Ordered width minus 1 1/8"
Bottom Rail Width:	Ordered width minus 1 1/16"	Ordered width minus 1 1/8"
Outside Mount and Exact Mount		
End Cap Cover to End Cap Cover:	Ordered width	Ordered width
Bracket to Bracket Measurement:	Ordered width minus 1/8"	Ordered width minus 1/8"
End to End Roller Width:	Ordered width minus 1 1/8"	Ordered width minus 1 3/16"
Fabric Width:	Ordered width minus 1 3/16"	Ordered width minus 1 1/4"
Bottom Rail Width:	Ordered width minus 1 3/16"	Ordered width minus 1 1/4"

Color Lux® Roller Shades

4" SKYLINE FASCIA WITH CORD LOOP AND SIMPLICITY MOTORIZATION



Motorized 4" Fascia in White



Motorized 4" Fascia Ivory



Motorized 4" Fascia in Black



Motorized 4" Fascia in Bronze



Motorized 4" Fascia in Satin Nickel

General Information

The 4" Skyline Fascia is a roller only shade with a 4" Skyline Fascia upgrade. The fascia clips over the standard roller shade during installation.

Inside Mount - Bracket covers are not available for inside mount shades due to the snap on installation method of the covers.

Outside Mount - Bracket covers are standard with all outside mount shades.

Operation Options

Skyline Clutch

PowerTouch Rechargeable Motorization

Simplicity Rechargeable Motorization

NEW Low Voltage Hardwired Motorization

Color Lux® Roller Shades

POWERTOUCH RECHARGEABLE FOR NO HEAD RAIL & DESIGNER CASSETTE

Color Lux Roller Shades can be fabricated with the PowerTouch™ Rechargeable option.

The PowerTouch™ Rechargeable provides an easy, cord free motorized operation for the budget savvy homeowner. PowerTouch™ Rechargeable uses Simplicity motors and components.



- PowerTouch™ Rechargeable is available for Roller Only and Designer Cassette
- The Roller Only option uses Skyline Hardware brackets and bracket covers available in White, Ivory, Black, Satin Nickel and Bronze. Wand and Pendant are always White or Black.

Color Lux Roller Shade PowerTouch™ Rechargeable Upgrade Surcharges

All standard discounts apply to PowerTouch™ Shades.

- PowerTouch™ Rechargeable Pendant and Wand: \$118.00
- Charger for PowerTouch™ Rechargeable (required): \$28.00

PowerTouch™ Rechargeable Roller Shade Specifications

See specific fabric price grids for minimum and maximum shade widths and lengths. Shade sizes in grey shaded sections are NOT available with the PowerTouch™ Rechargeable option.

PowerTouch™ Rechargeable Shades Operation

Press the up or down button on the pendant to raise or lower the shading to your desired position.

Programming the upper and lower limits is completed at the factory. These can be easily adjusted in the field if desired.

Programming the favorites position is completed after shade installation.

Please refer to the installation instructions at comfortex.com/comfortex-dealers.

PowerTouch™ Rechargeable Appearance

- The PowerTouch™ Rechargeable wand and pendant is attached to the head rail and requires no additional mounting.
- The No Head Rail PowerTouch™ Rechargeable wand must be attached to the motor before mounting.
- The wand and pendant hangs down the front of the shades
- The top and bottom buttons lift and lower the shade to the upper and lower limits. The center button is the favorites and stop button. from the head rail. The wand does not touch the fabric.
- Pendant is 2½" long.

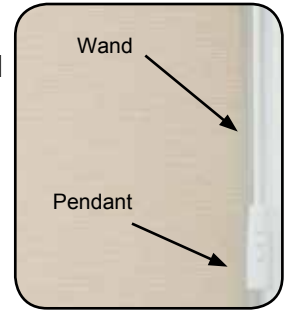

PowerTouch™ Rechargeable Color Options with Designer Cassette and No Head Rail Roller



White



Black

- Shades with Black or Oil Rubbed Bronze head rail will be built with black wand and pendants standard.
- Shades with White hardware will be built with white wand and pendants standard.
- Shades with Fabric Wrapped Head Rail will be built according to the head rail color selected.
- Shades booked as a no head rail roller will have a prompt to select wand color.

Wand and Pendant Location with Designer Cassette and No Head Rail Roller

The standard location for the wand and pendant is on the right. Please specify when ordering.

Color Lux® Roller Shades

POWERTOCH RECHARGEABLE FOR NO HEAD RAIL & DESIGNER CASSETTE

PowerTouch™ Rechargeable Wand Length with Designer Cassette and No Head Rail Roller

Shade Length	Standard Wand Length
Shades up to 30"	1' (12")
30" to 52"	2' (24")
52" to 78"	3' (36")
78" to 100"	4' (48")
100" to 120"	5' (60")

- Custom length wands are not available with PowerTouch™ Rechargeable. Standard wand lengths can be changed at no cost.

Mounting Requirements for PowerTouch™ Rechargeable Shades with Designer Cassette

- No special installation hardware or wiring requirements are needed to install PowerTouch™ Rechargeable Roller Shades with Designer Cassette Head Rail.
- A battery wand is not required with PowerTouch™ Rechargeable shades.

Mounting Requirements for PowerTouch™ Rechargeable Shades with No Head Rail Roller

- On No Head Rail roller shades, the wand must be attached to the motor with two screws (included) before mounting the shade.
- A battery wand is not required with PowerTouch™ Rechargeable shades.

PowerTouch™ Rechargeable Shades Do Not Have a Separate Battery Wand

There is no battery wand with the PowerTouch™ Rechargeable shades. The battery pack is integrated inside the roller tube to make mounting easier and more convenient.

The battery is recharged via the recharging port on the PowerTouch Rechargeable™ Wand.



Recharging Port

Minimum Width Requirements for PowerTouch™ Rechargeable Shades with and without Designer Cassette

Inside Mount = 18³/₈"
 Exact Mount = 18³/₁₆"
 Outside Mount = 18"

Battery Charger

8.4 Volt charger requires a standard power outlet to recharge the battery integrated within the motor. Must specify charger when ordering a PowerTouch Rechargeable shade. The charger plugs into the charger port. The charger is black and comes with a 156" (13') wire.



PowerTouch™ Rechargeable Roller Shades Warranty

Please see page 154 for complete Comfortex warranty information.

Color Lux® Roller Shades

SIMPLICITY RECHARGEABLE MOTORIZATION

The Simplicity Rechargeable Motorization program features an integrated rechargeable lithium ion battery in the motor casing and is fully concealed by the roller tube.

Simplicity Rechargeable Motorization Upgrades and Surcharges

Motor	
• Radio Frequency Motor: Includes integrated rechargeable battery	\$319.00
Hand Held Remote	
• 5 Channel Remote:	\$41.00
• 6 Channel Timer Remote:	\$67.00
• 14 Channel Remote	\$67.00
Simplicity Rechargeable Motor Battery Charger	
• Charger for rechargeable motors (required):	\$28.00
Simplicity Smart Controller	
• Smart Controller Unit	\$336.00
Simplicity Solar Panel	
• Solar Panel for Rechargeable Remote	\$105.00
All standard discounts apply.	

COLORLUX® ROLLER SHADES

Simplicity Rechargeable Motorization

All Roller Shade Fabrics

Minimum Width with No Head rail: 19½"
 Minimum Width in Designer Cassette: 18½"
 Maximum Width: See roller price grids for motorized shades specifications.

Simplicity Rechargeable Motors Appearance

The Simplicity Rechargeable motor and batteries are concealed within the roller tube.

Mounting Requirements

Standard Skyline Roller Hardware

No special installation hardware or wiring requirements are needed. See page 75 for mounting information.

Dual Roller Shades

No special installation hardware or wiring requirements are needed. See page 85 for mounting information.

Designer Cassette Hardware

No special installation hardware or wiring requirements are needed. See page 83 for mounting information.

4" Skyline Fascia Hardware

No special installation hardware or wiring requirements are needed. See page 91 for mounting information.

Simplicity Rechargeable Motor Batteries

The battery for the integrated rechargeable simplicity motor system is integrated within the motor casing and is fully concealed by the roller tube.

Rechargeable battery comes fully charged from the factory.

Battery Wand Mounting is Not Required

No external battery wand is required to operate a Color Lux Roller Shade with Simplicity Rechargeable Motorization.

Simplicity Rechargeable Motor Battery Life

Rechargeable battery is built into the motor.

The average battery charge will last 6-12 months based on an average sized shade raised and lowered once per day. The life of the battery charge will vary based on the type of window covering selected, the size and weight of the window covering and the number of times the shade is operated on a daily basis.

The battery can be recharged up to 500 times. It takes approximately 5 hours to recharge the motor when fully depleted.

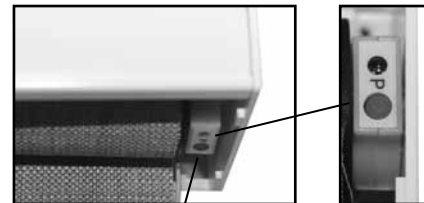

Charging Port

Close-Up

Battery Charger for Simplicity Rechargeable Motors

An 8.4 Volt charger requires a standard power outlet to recharge the battery. The charger must be specified when ordering a Rechargeable Simplicity Motorized shade. The charger plugs into the charging port of the motor.

The charger is black and comes with a 156" (13') wire. The dimensions are 1" wide x 2½" length x 1¾" deep.



Color Lux® Roller Shades

SIMPLICITY RECHARGEABLE MOTORIZATION

Heavy Duty Simplicity Rechargeable Motorization for 2" and 2½" tubes

Heavy Duty Motors are now available for all roller shades that require a 2" or 2½" tube. See shaded sections in each fabric grid for sizes. Motors are only available with the no head rail option. Brackets are only white and no bracket covers are available. Even if not required, Heavy Duty Motorization can be ordered for smaller shades to maintain consistent appearance.

Heavy Duty Motorization is NOT available with Designer Cassette or Fascia options.

Minimum Width of Heavy Duty Motorized Shades is 24".

Battery is integrated within the motor unit.

The 12 Volt charger must be used to recharge heavy duty motors. **Solar Panel Option is NOT available for Heavy Duty Motorization.**



Spring Loaded Idler



Motorized End

Envision Roller Shades with Heavy Duty Motorization

All standard discounts apply.

- Heavy Duty Simplicity Rechargeable Motorization: \$434.00
- 12V Charger for Heavy Duty Simplicity Rechargeable Motorization (required): \$59.00

All standard discounts apply.

Bracket Dimensions

Projection = 3⅝"

Width = 3"

Minimum Mounting Depth = 2"

Minimum Flush Mounting Depth = 3"

Minimum Side Mounting Depth = 3"



Important Information about Simplicity Rechargeable Motor Shade Operation and Installation

- Simplicity Motorized Shadings installed into windows with metal casings may have a reduced radio frequency range, or may not operate at all, depending on the application.
- Do not let the antenna on the motor touch any metal objects. This may interfere with signals from the remote control.
- Be mindful of when your shade starts to slow down during operation. It is a good indicator the shade needs to be recharged. The shade will also beep when the remote button is pressed if the battery is low.

New Solar Panel Option

Dimensions: 19" x 1½"

The new solar panel option with mounting brackets plugs into any Simplicity Rechargeable Remote control shade (does not work with PowerTouch).

The solar panel provides a constant trickle charge to the 7.4v Li-Ion Rechargeable battery packs. It does not require direct sunlight, but performs best in direct sunlight applications.

This option prolongs the life of the charge of the 7.4v rechargeable battery packs, and in some applications will maintain charge indefinitely.

Life of charge is subject to application variables, such as size and weight of the shade, frequency of shade use, amount of direct sunlight exposure, etc.



Color Lux® Roller Shades

7.4V SIMPLICITY RECHARGEABLE HARDWARE SYSTEM

EZ Charge Extension Wand Option

EZ Charge Extension Wand is the newest innovation in rechargeable motorization. Easily charge your hard to reach Simplicity Rechargeable Shades with the EZ Charge Extension Wand. The wand extends up to 31" in length.

Simple to use! Place the magnetized wand tip on the receiving port to attach. Then plug the charger into the base of the wand. It is that simple!

- EZ Charge Extension Wand can be easily concealed by a valance or drapery panel.
- Great for out of reach window

EZ Charge Wall Mount Receiver

- The EZ Charge Wall Mount Receiver includes screws and anchors. These can be used for wood or drywall mounting.
- Extension cable plugs into charging port of Simplicity Rechargeable shades.



EZ Charge Wall Mount Receiver Kit | CKIT078
One kit per Simplicity Motorized shade is needed.

EZ Charge Extension Wand Option

All standard discounts apply.

- EZ Charge Wall Mount Receiver: \$20.00 List Price
- EZ Charge Wand: \$37.00 List Price

EZ Charge Wand

- Wand is 9½" and extends to 31"
- Magnetized tip makes connection quick and easy.
- Once wand is in place plug the 8.4v charger into the bottom of the extension wand for charging.

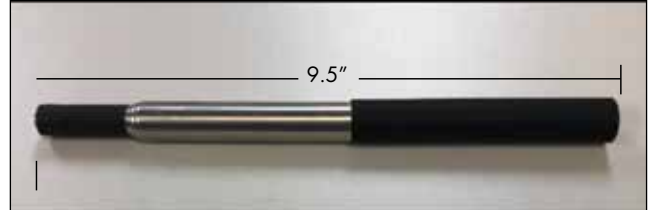

EZ Charge Wand | CKIT077
Order with the EZ Charge Wall Mount Receiver Kit



EZ Charge Receiving Port



Port/Wand Connection



Battery Charger



Wand Base

Battery Charger - SOLD SEPARATELY

You must specify charger when ordering a Simplicity Rechargeable Motorized Shade. The charger plugs into the wand base. The 8.4 Volt charger requires a standard power outlet to recharge the motor. The charger is black and comes with a 1.56" wire. The dimensions are 1" wide x 2½" length x 1¾" deep.

Color Lux® Roller Shades

12V SIMPLICITY LOW VOLTAGE HARDWIRING SYSTEM

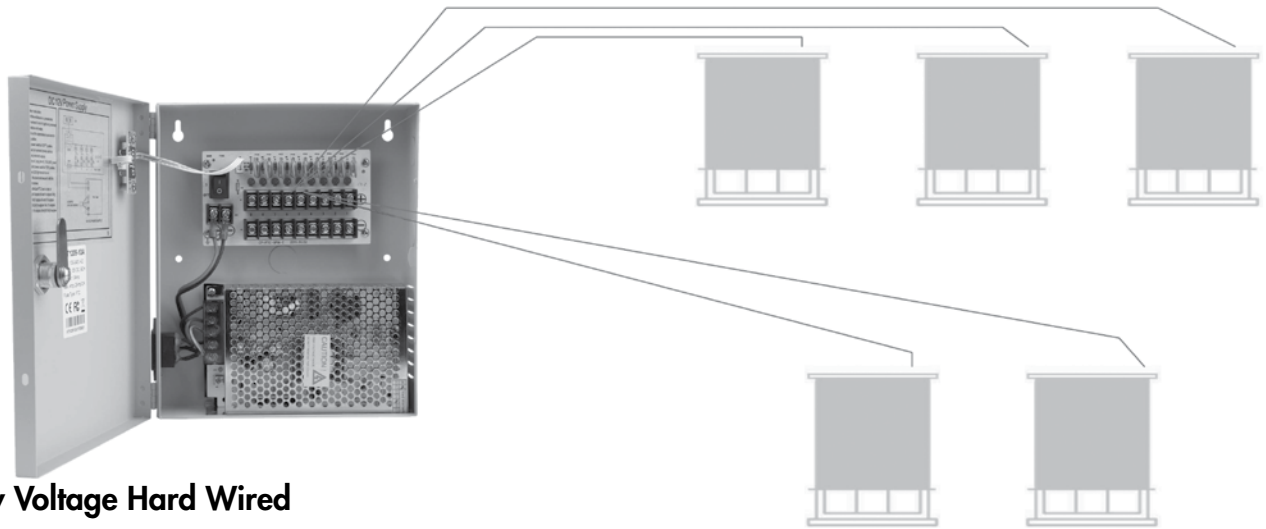

12V Low Voltage Hard Wired

Low Voltage hardwire powered motors are available for all Roller Shades up to a 1.5" tube. **Heavy Duty Motors are NOT available with Low Voltage Hard Wired Motorization.** The system offers a maintenance-free power option for Simplicity Motorized Shades. The Simplicity power transformer mounts in a safe dry location (such as your basement), out of sight, and provides power for up to nine individual shades per box.

Simplicity Motorized Upgrade and Surcharges

Standard Envision Discounts apply to motorized lift systems pricing.

Wall Mount Transformer

- Wall Mount Transformer \$263.00

2 Conductor wires should be pre-installed by a licensed contractor according to local building codes, to connect power from the transformer to the shades.

Simply use the wire adapters provided to connect the power wire to the Simplicity motor power input on the back of the shade, then connect the pre-run wires to the (+ / -) terminal block in the transformer box, and flip on the power switch.

- Product Dimension: 7.875" wide, 9.4" Tall, 2.45" deep
- Converts incoming 120V AC to outgoing 12V for up to 9 shades.

• Product Description:

- 12v10a 9ch
- Input Voltage Range : AC90V-264V
- Input Frequency Range : 50Hz-60Hz
- Output Voltage Range : DC12V+/-5%
- Output Current : 10 Ampere
- Output Power : 120 Watt
- Output Ripple&Noise : ≤42MV
- Output Efficiency : ≥83%
- Output Fuse Type : PTC
- Output Fuse Rating : 2A
- Environment Operating Amb.Temp : -30 ~45
20%~90%RH
- Environment Storage Temp : -40 ~85 10%~95%RH



2 Conductor Wires running to basement 12V Power Transformer

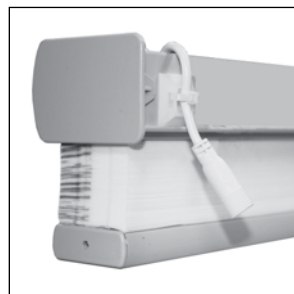

Power port on back of shade



Wires connecting to charging port on Simplicity shade



12V Wall Mount 9 Channel Power Transformer

- Transformer plugs into standard household outlet.
- Powercord is 56" in length.

COLORLUX® ROLLER SHADES

Color Lux® Roller Shades

12V SIMPLICITY MOTORIZATION



Color Lux Roller Shades can be motorized with the non-rechargeable Simplicity Motorization system. The Simplicity Motor program features a battery powered motor and includes a single 12 volt battery wand. Simplicity motors are compact and use a radio controlled remote to raise or lower the shades.

Head Rail Options with Simplicity Motors:

- R-Series
- Skyline Standard Roller
- Designer Cassette
- 3" Fascia
- 4" Skyline Fascia

Simplicity Motorized Upgrade and Surcharges

Standard Envision Discounts apply to motorized lift systems pricing.

Motor	
• Radio Frequency Motor with battery wand:	\$319.00
Hand Held Remote	
• 5 Channel Remote:	\$41.00
• 6 Channel Timer Remote:	\$67.00
• 14 Channel Remote	\$67.00
DC Power Supply - Replaces Battery Wand	
• Wall mount transformer DC12V/2A	\$80.00
Battery Wand Extension Wires	
• 48" Extension Wire	\$20.00
All standard discounts apply.	

The 6 Channel Timer Remote can operate up to six shades individually or in groups and has a timer feature to create schedules for automatic shade operation.

Standard Simplicity Motor Battery Life and Replacement

Eight alkaline batteries are included with the wand. The battery life will vary based on the type of window covering selected, the size and weight of the window covering and the number of times you operate the shade on a daily basis.

Comfortex will warranty batteries for up to 3 months from date of purchase. Batteries are not covered by the limited lifetime warranty.

12V Simplicity Motorization Minimum Shade Sizes

Minimum Width with No Head rail: 14"
 Minimum Width in Designer Cassette: 14"
 Maximum Width: See roller price grids for motorized shades specifications.

Standard Roller Hardware Appearance Shade Features

- **Bottom rail style:** Fabric Wrapped or Exposed bottom rail
- **Bottom rail color:**
Fabric Wrapped: White, vanilla, bronze, black or brushed aluminum.
Exposed: White, vanilla, bronze, black or brushed aluminum.

The motor lead is 6" long and the battery wire is 10" long.



White and Black Adapters for Skyline Motorization with no head rail

DC Power Supply

12 Volt DC power supply is available and requires a standard power outlet to power the motor. The transformer is an alternative to a battery wand. Each transformer can power a single shade with a Simplicity motor. The power supply must plug in to the motor. The DC power supply is white and comes with a 80" wire. The dimensions are 1 7/8" wide x 3 1/4" length x 1 1/4" deep.



Standard Simplicity Motor Battery Wand Mounting

The battery wand is wall or ceiling mounted utilizing white battery wand clips. It also can be clipped to the Designer Cassette head rail.

Batteries are needed to operate Simplicity motors. The battery wand measures 17 1/4" and comes with eight alkaline batteries and is white in color.



Battery Wand

COLORLUX® ROLLER SHADES

Color Lux® Roller Shades

SIMPLICITY MOTORIZATION

Simplicity 7.4V Rechargeable and 12V Remote Control Options

Simplicity 5 Channel Remote

The Simplicity Remote features 5 individual frequency channels and an All channel that will operate all the shades at once.

The 5 Channel Simplicity remote is available in white and black. All remotes come with a holder which can be mounted to a wall for easy storage.



The remote controls utilizes one 3V battery (CR2430). Batteries are included. Comfortex will warranty batteries for up to 3 months from date of purchase. Remote control batteries are not covered by the limited lifetime warranty.

Standard Simplicity Battery Operated Motorized Shades Warranty

Please see page 153-154 for complete Comfortex warranty information.

Simplicity 14 Channel Remote

The Simplicity 14 Channel remote can operate up to fourteen shades individually or 14 groups. Simplicity Rechargeable Motorized Roller Shades are programmed at the factory with the “up and down” limits. The shades are **UNLINKED** from the remote so they are not able to operate during shipping. Each shade should be installed **after** linking it to the remote.



Simplicity 14 Channel remotes and holders are white in color. The remote comes with a holder which can be mounted to a wall for easy storage. The range of the remote is approximately 80 feet. A 14 Channel (14C) remote can be utilized on all Simplicity Motorized Shades.

Please Note: Unused channels can be hidden

Simplicity 6 Channel Timer Remote

The 6 Channel (6C) timer remote combines the functionality of a six channel hand-held control with the convenience of a programmable timer.

- The 6C timer remote allows for different scheduled actions each day of the week.
- Manual function disables the timer and the remote then operates as a 6-channel hand held remote.



Simplicity 6C remotes and holders are white in color. The remote comes with a holder which can be mounted to a wall for easy storage. The range of the remote is approximately 80 feet.

THE FACTORY DOES NOT PROGRAM CHANNELS FOR SIMPLICITY RECHARGEABLE MOTORS.

The factory programs the upper and lower limits of every shade. Channel programming is completed after shade installation.

Please Note:

- Not all motors run at the same rate of speed.
- **REMOTES ARE NOT LINKED TO SHADES FROM THE FACTORY. SHADES MUST BE LINKED AFTER SHADE INSTALLATION.**
- Simplicity motors have a “Favorites” position setting. If the homeowner wants to set several shadings at the same intermediate position, follow instructions provided with installation manual.
- **WHEN ORDERING THE SIMPLICITY RECHARGEABLE, PLEASE ORDER THE NECESSARY BATTERY CHARGER.**

COLORLUX® ROLLER SHADES

Color Lux® Roller Shades

COLOR LUX® HIGHLIGHTS CORNICE VALANCE WITH KEYSTONE

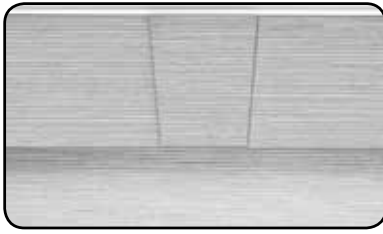

Highlight any element of your home décor with the Highlights Cornice Valance upgrade. This tailored, fabric wrapped valance, available in seven heights with seven returns sized from 1½" to 6", mounts over any product, either inside or outside the frame. The Keystone option now allows for all fabrics to cover widths up to 216". It's the perfect solution for our Panel Track system. Highlights Valances can ONLY be ordered as a STANDALONE product.

Width In Inches

	24	30	36	42	48	54	60	66	72	78	84	94	96	102	108	114	120	132	144	156	168	180	192	204	216	
6" & 8" Highlights Cornice Valance NO Keystone	147	163	178	194	210	219	231	242	253	263	275	293	Not Available. See One Keystone Option.													
6" & 8" Highlights Cornice Valance with ONE Keystone	198	214	230	244	261	271	282	295	303	315	326	345	349	360	370	381	393	409	419	431	445	457	Not Available. See Two keystones			
6" & 8" Highlights Cornice Valance with TWO Keystones	Two Keystones are not available unless required due to fabric width.																			470	483	496	509	522	537	552
10", 12", 14", 16" Highlights Cornice Valance NO Keystone	198	220	241	262	284	296	312	326	341	355	372	395	Not Available. See One Keystone Option.													
10", 12", 14", 16" Highlights Cornice Valance with ONE Keystone	267	289	311	329	352	366	381	398	409	425	441	465	471	486	500	515	530	552	566	582	600	617	Not Available. See Two Keystones			
10", 12", 14", 16" Highlights Cornice Valance with TWO Keystones	Two Keystones are not available unless required due to fabric width.																			635	653	669	687	705	725	745

Highlights Valance Specifications

Valance Width with Keystone: Maximum valance width is 216" for all Color Lux Roller Fabrics.

- Fabric cannot be railroaded
- Keystone placement is pre-determined. Custom placement is not available.
- Seaming is not available.
- Multiple Keystones may be required for larger widths. (ex. 216" Highlights Valance will require TWO Keystones, each 72" wide).

Valance Heights: 6", 8", 12", 14" and 16"

Standard Return Sizes:

- Inside Mount: None
- Outside Mount: See chart below.

Highlights Cornice Valance Upgrade can ONLY be ordered as a SEPARATE stand alone product. They cannot be ordered with shades.

Highlights Ordering and Measuring Instructions Inside Mount Valance ordered SEPARATELY

- Inside mount valances are made without returns.
- An inside mount Highlights Valance will come with its own set of mounting brackets. In most scenarios, the valance brackets must be installed separately from the shade.
- Measure the inside width at the top of the window where the valance is to be installed. Measure in multiple spots to ensure accuracy. If there are variances, supply the smallest measurement.
- **Please Note:** The finished dimension of your inside mount bracket will be 3/16" less than your ordered width (see Figure A). Example: An inside mount valance ordered at 36" wide will be made 35 13/16".
- **Please Note:** You will need up to 3 1/2" of mounting depth to ensure your valance is fully recessed and flush with your window opening.

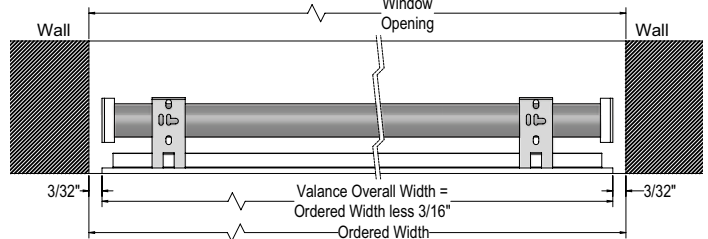

Figure A

Mounting Information for Highlight Valances with Returns Size Options

Style	Return Size	Mounting Depth Required	Inside Valance Depth Clearance Provided	Comments
Inside Mount	None	3" for flush	N/A	Mounted inside window opening
Shallow Mount	1 ½"	1 ½"	7/8"	Outside Mount with bracket mounted inside window
Shallow Mount	2"	1"	1 3/8"	Outside Mount with bracket mounted inside window
Shallow Mount	2 ½"	½"	1 7/8"	Outside Mount with bracket mounted inside window
Outside Mount	3"	½" surface height	2 3/8"	Valance will be mounted outside window
Outside Mount	4"	½" surface height	3 3/8"	Valance will be mounted outside window
Outside Mount	5"	½" surface height	4 3/8"	Valance will be mounted outside window
Outside Mount	6"	½" surface height	5 3/8"	Valance will be mounted outside window

Color Lux® Roller Shades

COLOR LUX® HIGHLIGHTS CORNICE VALANCE WITH KEYSTONE

Highlights Ordering and Measuring Instructions

Outside Mount Valance ordered SEPARATELY

- Outside mount valances come in seven return options.
- An outside mount Highlights Valance will come with its own set of mounting brackets. In most scenarios, the valance brackets must be installed separately from the shade.
- Measure the width of the area you wish to cover. Be sure to add extra space if you have window trim or extra wall space you'd like to cover.
- **Please Note:** When ordering outside mount valances, the finished overall width of your valance will be your ordered width plus 1 1/4" (see Figures B and C). **Example:** An outside mount valance ordered at 36" wide will be made 37 1/4".
- **Please Note:** You will need 1/2" of surface area to mount your valance (see Figure B).

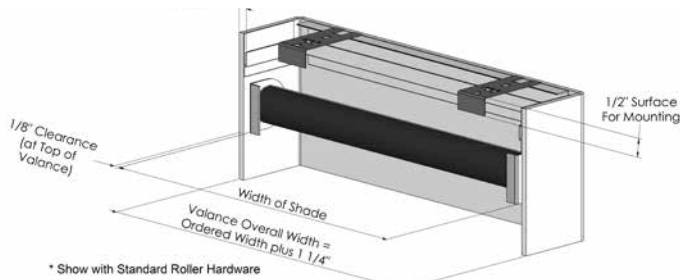

Figure B

Outside Mount

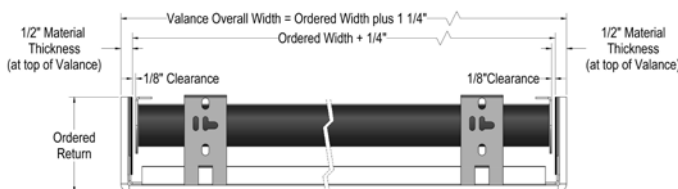

Figure C

Valance with Return Size Options

- Measure the width of the area you wish to cover. Be sure to add extra space if you have window trim or extra wall space you'd like to cover. See Figures D-F for measuring information.
- Next, determine the length of your desired returns. Use the chart on page 88 for the mounting depth required and inside valance depth clearance provided for each return size.

Outside Mount

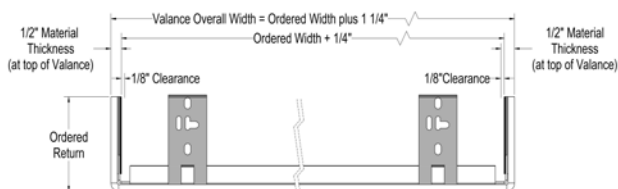

Figure D

Valance Return Size Options (Cont.)

Inside Mount

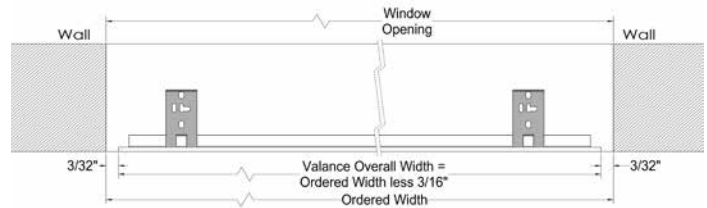

Figure E

Shallow Mount

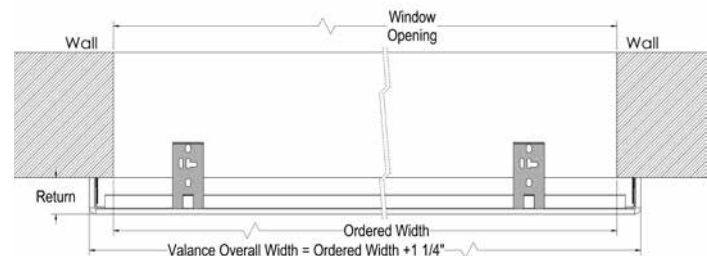

Figure F

Valance Returns

- Seven return size options are available.
- **Return Sizes:** To determine a return length, add the component dimensions (mounting brackets, etc.) up to the wall. Subtract the measurements from any protrusions (molding, etc.), then choose from one of the pre-determined return sizes (from the chart on page 88 that best fits your application).
- **Return Coverage**
Ordered return size refers to the distance from the face of the valance to the back of return. See Figure G.

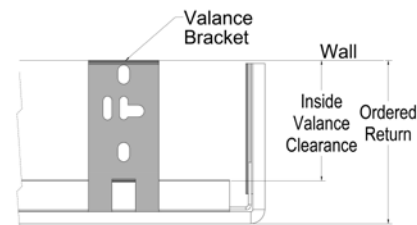

Figure G

Clearances

Shallow Mount Bracket

- 1 1/2" Return provides an inside valance clearance of 7/8".
- 2" Return provides an inside valance clearance of 1 3/8".
- 2 1/2" Return provides an inside valance clearance of 1 7/8".

Outside Mount Bracket

- 3" Return provides an inside valance clearance of 2 3/8".
- 4" Return provides an inside valance clearance of 3 3/8".
- 5" Return provides an inside valance clearance of 4 3/8".
- 6" Return provides an inside valance clearance of 5 3/8".

COLORLUX® ROLLER SHADES

Color Lux® Roller Shades

COLOR LUX® HIGHLIGHTS CORNICE VALANCE WITH KEYSTONE

Keystone Specification

- All keystones will automatically be wrapped with matching Color Lux Roller Fabric.
- Available in Classic Duck, Linen and Solar Screen 5.
- Keystones will be provided separately and installed on site.
- Ordering two optional keystones is currently not available. Two keystones may be required for some wider width valances.
- Valance panels are divided in half when the Keystone option is ordered. Custom locations for keystone placement is not available.

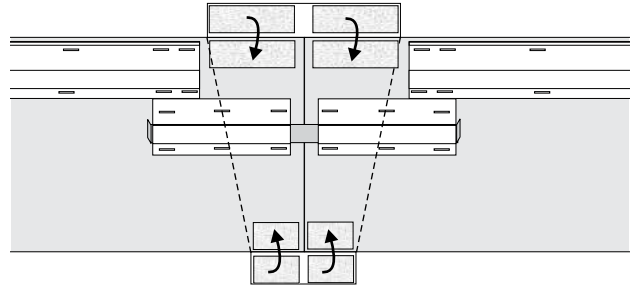

Rear view of the Highlights Valance Keystone. Not visible to room side.



Front view of the Highlights Valance Keystone.

Keystones for Panel Tracks

- Keystones ordered for Panel Tracks should use the return sizes list below to ensure clearance of the Panel Track Rail.
- **2 Panels Side or 4 Panel Split = minimum 3" returns**
- **3 Panels Side = minimum 3" returns**
- **4 Panels Side or 6 Panel Split = minimum 4" returns**
- **5 Panels Side or 8 Panel Split = minimum 4" returns**

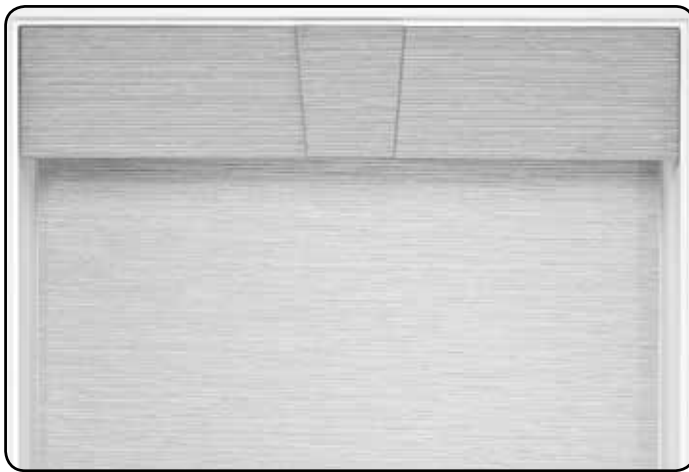

A Keystone option is available for all shade widths so every Highlights Valance in a room will be uniform

Color Lux Custom Graphics for Highlights Cornice Valance.

Custom Graphics is available for Highlights Cornice Valance without a Keystone only.

- Available in Classic Duck Light Filtering, Classic Duck Blackout, and 5% Scree (5% Screen is only available on Custom Graphics).
- Add 25% to Standard Rectangular Price on page 88.

Color Lux® Fabric Cornice from Designer Window Solutions

Color Lux Designer Window Solutions now offers a beautiful new cornice option using **Color Lux Linen and Sateen Drapery** fabrics. Color Lux Fabric Cornice is NOT available with Color Lux Roller shade fabrics. Available in heights ranging from 6" to 16", with return sizes from 3" to 7", this cornice is sure to fit any application in the home. They are designed to coordinate beautifully with all Color Lux solid colors and are a perfect top treatment for other hard or soft window treatments.

See the 2020 Color Lux Designer Window Solutions Manufacturer's Price List and Reference Guide for more information!



COLOR LUX® PANEL TRACK SYSTEM



COLOR LUX®
Designer Cellular & Roller Shades

COLORLUX® PANEL TRACK SHADES

Color Lux® Panel Track Shades

SYSTEM FEATURES & OPTIONS

The Color Lux Panel Track Shade system offers versatility and a beautiful modern design for effective light control and outstanding performance. Panel track systems are a beautiful option for large windows and room dividers. Available in Classic Duck and Linen Light Filtering and Blackout, and Solar Screen 5.

Stacking Options

Color Lux Panel Track Shades are available with 3 stacking configurations: split, left and right stacks.

- Split stack panels draw open to both sides equally. Controls may be placed on either side and is only available in cord control.
- Side stack is available as left or right stack and is available with a white wand or cord control.



Split Stack



Left or Right Stack



Closed Side Stack

Panel Attachment

A hook and loop strip is sewn onto every panel to provide a secure attachment. The patented panel attach method makes it easy to attach the panels even after installation of the rail.

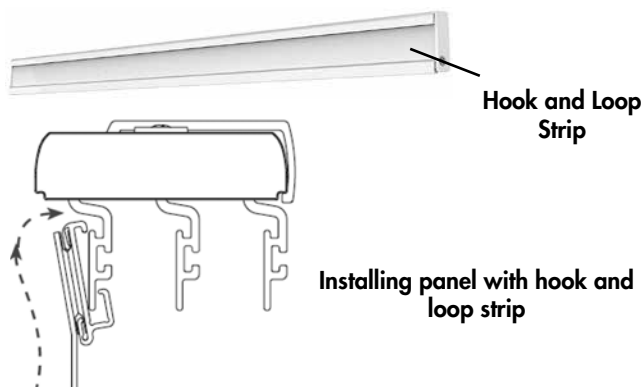

Head Rail Colors

Select from the white or aluminum system hardware system. (Wand is always white.)



White Head Rail



Aluminum Head Rail

Bottom Rail

Panel track bottom rails are designed for smooth operation and allows all panels to glide smoothly past each other.

- Bottom rails are designed to match perfectly with the head rail in exposed white or silver.
- Finished bottom rails will be 1/2" higher than measured drop on inside mount shades.
- Bottom rails are not connected to each other on this panel track system.
- Fabric Wrapped bottom rails are available as an option.



Fabric Wrapped Bottom Rail

Fabric Panels and Custom Overlaps

Classic Duck Light Filtering and Blackout are both available with the Color Lux Panel Track Shade System.

- Panels will be fabricated with a 2" overlap as standard. Custom overlaps are available at 1 1/2", 2 1/2" and 3". Please specify when ordering.
- Panels are attached with a hook and loop strip to allow for subtle fabric adjustment in the field.
- Each panel traverses the track using ball bearings, creating smooth operation for wand and cord control
- Panels follow a single lead panel in sequence to open and close.
- Panels position exactly behind one another in the open position.
- There is no light gap between the rail and the panels.
- Panels will reach the end of the track.

Please Note: Panels may not hang perfectly flat immediately upon installation. Panels may have a billowing or wavy appearance at the time of installation which may correct itself over time.

Replacement panels are available.

COLORLUX® PANEL TRACK SHADES

Color Lux® Panel Track Shades

SYSTEM FEATURES & OPTIONS

Control Options

The panel track system uses a cord or wand for traversing the fabric panels. Cord control is standard with every panel track shade. Wand control is available at no additional surcharge. Please specify when ordering.

Cord Control

- The nylon cord is white or grey to coordinate with hardware.
- Standard length of the cord is 10" less the ordered length. Custom cord lengths are available. Please specify when ordering.
- Standard cord placement is right stack with right cord.
- Operating cords are located on the outside edge of the panels.
- Tensioner for cord control is always white.
- Tensioner must always be placed so the cord reaches full extension.



Grey Cord Control

Wand Control

The traversing wand is a convenient alternative to a traditional cord control. This single control system protects children and pets from injuries caused by loop cords.



White Wand Control

- The wand control is always white.
- Only available on side stack systems.
- Standard wand placement is on the outside leading edge of the left or right stack.

Standard Wand Lengths

- Shades up to 72" in Length: 36" wand
- 72" to 96" in Length: 48" wand
- 96" to 120" in Length: 60" wand
- 120" to 144" in Length: 72" wand

Custom lengths are not available but you may select from one of the standard wand lengths above.

Panel Widths

To achieve the best performance on this panel track system, panels are designed within the following parameters:

- The minimum width for a single panel is 6".**
- The maximum width for a single panel is 48".**
- The maximum panel height is 144".**

See price grids for the minimum number of panels that will be available at the desired width.

More panels can be ordered at an additional surcharge and to achieve the desired panel width.

The standard panel overlap is 2". Custom overlaps are available.

Example: The standard split stack on a 96" wide opening would have 4 panels at 26" wide with a 2" overlap. If 6 panels are desired, each panel would be 18" wide.

Track Specifications

- The minimum width of a track is 18".**
- The maximum width of a track is 216".**

The maximum width of a single panel track is 216". When the total width is ordered over 100", tracks will be split in half and a connector bracket will be provided.

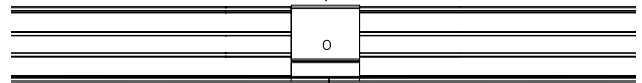

Panel Stack Back

The stack back will be equal to a single panel width. It will never be less than 12" and never exceed 48".

To determine an approximate stack back:

Ordered Width ÷ Number of Panels = Stack Back within +/- 2". (with 2" standard overlap)

Color Lux Custom Graphics for Panel Track

Custom Graphics is available on Panel Track Shades in the following fabrics:

- Classic Duck Light Filtering
- Classic Duck Blackout
- 5% Screen (only available for Custom Graphics)

Add 25% to Standard Rectangular price plus desired upgrades.

Color Lux® Panel Track Shades
All Color Lux Roller Fabrics

GRID #24
Center Split Stack
Standard Cord Draw

Standard #

of Panels	4 Panels	4 Panels	4 Panels	4 Panels	4 Panels	4 Panels	4 Panels	4 Panels	6 Panels	6 Panels	
Panel Width	11"	14"	17"	20"	26"	32"	38"	44"	34"	38"	
	Width In Inches										
	36	48	60	72	96	120	144	168	192	216	
Length in Inches	48	724	831	880	989	1212	1381	1605	1764	1878	1988
	60	741	853	903	1015	1243	1417	1649	1811	1928	2040
	72	759	874	923	1039	1275	1451	1691	1857	1978	2093
	84	775	894	943	1063	1306	1487	1733	1902	2028	2145
	96	793	915	965	1088	1338	1524	1777	1951	2078	2197
	108	810	938	987	1113	1369	1559	1818	1995	2128	2251
	120	828	957	1006	1138	1402	1595	1862	2043	2179	2303
	132	845	979	1065	1163	1433	1669	1904	2128	2268	2397
144	863	1000	1091	1187	1466	1708	1949	2179	2321	2454	

Surcharge for Additional Panels

6 Panels	—	—	35	47	61	75	89	102	—	—
8 Panels	—	—	—	—	122	151	178	204	124	139

Panel Width (Inches) (Approximate*)

6 Panels	—	—	10"	12"	16"	20"	24"	28"	—	—
8 Panels	—	—	—	—	12"	15"	18"	21"	24"	27"

* Measurements do not account for standard deductions to fabric and head rail and use standard 2" overlap.

GRID #25 One Way Side Stack
Standard Cord Draw

Standard #

of Panels	2 Panels	2 Panels	2 Panels	2 Panels	3 Panels	3 Panels	4 Panels	4 Panels	5 Panels	5 Panels	
Panel Width	20"	26"	32"	38"	34"	42"	38"	44"	40"	43"	
	Width In Inches										
	36	48	60	72	96	120	144	168	192	216	
Length in Inches	48	724	831	880	989	1212	1381	1605	1764	1878	1988
	60	741	853	903	1015	1243	1417	1649	1811	1928	2040
	72	759	874	923	1039	1275	1451	1691	1857	1978	2093
	84	775	894	943	1063	1306	1487	1733	1902	2028	2145
	96	793	915	965	1088	1338	1524	1777	1951	2078	2197
	108	810	938	987	1113	1369	1559	1818	1995	2128	2251
	120	828	957	1006	1138	1402	1595	1862	2043	2179	2303
	132	845	979	1065	1163	1433	1669	1904	2128	2268	2397
144	863	1000	1091	1187	1466	1708	1949	2179	2321	2454	

Surcharge for Additional Panels

3 Panels	25	32	41	47	—	—	—	—	—	—
4 Panels	—	63	84	95	122	76	—	—	—	—
5 Panels	—	—	166	189	243	153	187	114	—	—

Panel Width (Inches) (Approximate*)

3 Panels	12"	16"	20"	24"	—	—	—	—	—	—
4 Panels	—	12"	15"	18"	24"	30"	—	—	—	—
5 Panels	—	—	12"	14"	19"	26"	29"	34"	—	—

* Measurements do not account for standard deductions to fabric and head rail and use standard 2" overlap.

Scotchgard™ Stain Protection Add \$50 to the standard rectangular price.

Product Specifications

Head Rail Options

- White
- Aluminum

Bottom Rail Options

- White
- Aluminum

Control Options

- Cord Draw (standard)
- Wand Draw (wand is always white)

Panel Size

- Minimum panel width is 6"
- Maximum panel width is 48"

COLORLUX® PANEL TRACK SHADES

Color Lux® Panel Track Shades
SPECIFICATIONS

Panel Track Finished Dimensions

	Inside Mount - Cord Draw	Inside Mount - Wand Draw	Outside Mount - Cord Draw	Outside Mount - Wand Draw
Width of Finished Panel Coverage	Ordered Width minus 5/8"	Ordered Width minus 5/8"	Ordered Width minus 3/8"	Ordered Width minus 3/8"
Track	Ordered Width minus 1/4"	Ordered Width minus 1/4"	Ordered Width	Ordered Width
Length	Ordered Length minus 1/2"	Ordered Length minus 1/2"	Ordered Length	Ordered Length

Mounting Options

The following mounting options are available. All mounting brackets are coordinated with the head rail in white or aluminum:

- Wall Bracket with End Caps
- Ceiling Bracket with End Caps

Light Gap

Head Rail/Fabric Panels: There is no light gap between the fabric panels and the bottom of the head rail.

Outside Mount Bracket/Head Rail: There is a 1/4" light gap between the top of the track to the top of the outside mount installation bracket.

Inside Mount Bracket/Head Rail: There is a 1/8" gap between the top of the track to the top of the inside mount installation bracket.

Bottom Light Gap: There will be a 1/2" light gap at the bottom of the hanging panels on an inside mount shade.

Side Light Gap: There will be 3/16" side light gap at the sides of the panel track.

To avoid side light gap on outside mount shades, Comfortex recommends increasing the ordered width by 5", or 2 1/2" on both sides.

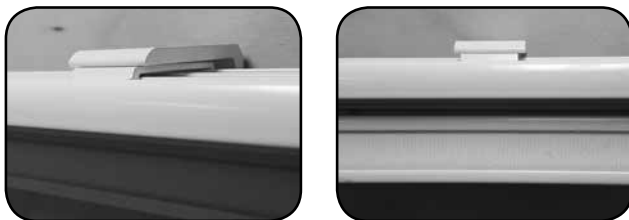

Outside Mount Installation Bracket Appearance

Fabric Deductions and Specifications

Panels are fabricated with a 2" overlap as standard. Custom overlaps are available in 1 1/2", 2 1/2" or 3".

Inside Mount:

Head rail width = ordered width minus 1/4"

Panel height allowance = ordered length minus 1/2"

Outside Mount:

No additional deductions are taken for fabric width

Panel height allowance = ordered length

Highlights Valance for Panel Track with Keystone

See pages 101 - 103 for more information on the Color Lux Highlights Cornice Valance for your Panel Track system.

- Keystones ordered for Panel Tracks should use return sizes list below to ensure clearance of the Panel Track Rail.
- **2 Panels Side or 4 Panel Split = minimum 3" returns**
- **3 Panels Side = minimum 3" returns**
- **4 Panels Side or 6 Panel Split = minimum 4" returns**
- **5 Panels Side or 8 Panel Split = minimum 4" returns**
- Keystones automatically match the color and fabric of the ordered Color Lux Highlights Valance. Custom color options are not available.
- Valance panels are divided in half when the Keystone option is ordered. Custom locations for keystone placement is not available.
- Ordering two optional keystones is currently not available.
- Multiple Keystones may be required for larger widths. (ex. A Highlights Valance with an ordered width of 216" will require TWO Keystone. All three valances will be 72" wide, excluding returns).
- The front panel on a split stack will overlap the back panel as illustrated on page 103.

COLORLUX® PANEL TRACK SHADES

Highlights Cornice Valance with Keystone for Panel Track Shades

	24	30	36	42	48	54	60	66	72	78	84	94	96	102	108	114	120	132	144	156	168	180	192	204	216
6" & 8" Highlights Cornice Valance NO Keystone	147	163	178	194	210	219	231	242	253	263	275	293	Not Available. See One Keystone Option.												
6" & 8" Highlights Cornice Valance with ONE Keystone	198	214	230	244	261	271	282	295	303	315	326	345	349	360	370	381	393	409	419	431	445	457	Not Available. See Two Keystones		
6" & 8" Highlights Cornice Valance with TWO Keystones	Two Keystones are not available unless required due to fabric width.																		470	483	496	509	522	537	552

Color Lux® Panel Track Shades

SPECIFICATIONS

Clear Window Opening

Panel Tracks are an excellent option for clearing a window opening. Please see the below charts for guidance on what ordered width is recommended to clear a window opening.

For Example:

For a One Way Side Stack ordered with 5 panels, in order to clear an opening of 94", the ordered width of the panel track should be 120".

One Way Side Stack Panel Track

Step 1: Select # of Panels

Step 2: Select uncovered width

2 Panels	If uncovered width is	17	23	29	35	-	-	-	-	-	-
3 Panels	If uncovered width is	23	31	39	47	63	79	-	-	-	-
4 Panels	If uncovered width is	25	34	43	52	70	88	106	124	-	-
5 Panels	If uncovered width is	27	37	47	56	75	94	113	133	152	171
Result: Then Ordered Width is		36	48	60	72	96	120	144	168	192	216

Split Stack Panel Track

Step 1: Select # of Panels

Step 2: Select uncovered width

4 Panels	If uncovered width is	14	20	26	32	44	56	68	80	-	-
6 Panels	If uncovered width is	-	-	36	44	60	76	92	108	124	140
8 Panels	If uncovered width is	-	-	-	-	68	86	104	122	140	158
Result: Then Ordered Width is		36	48	60	72	96	120	144	168	192	216

Panel Configuration - Wand and Cord Control

The lead panel is always in front and catches the panels behind it. Right stack and split stack panel configuration is shown below.

**Right Stack
Wand Control**

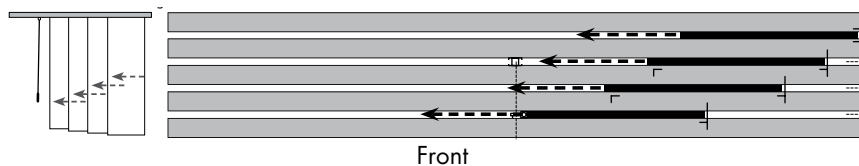

**Right Stack
Cord Control**

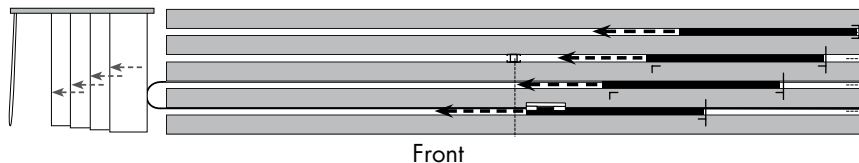

**Split Stack
Cord Control**

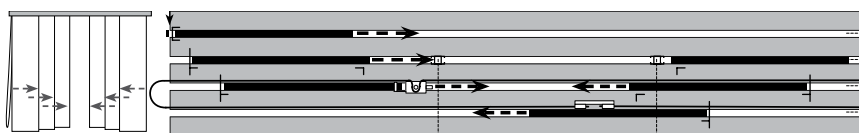

Color Lux® Panel Track Shades

SPECIFICATIONS

Outside Mount Hardware Profiles

Five separate panel track profiles are available depending on the number of panels ordered.

Two Track System

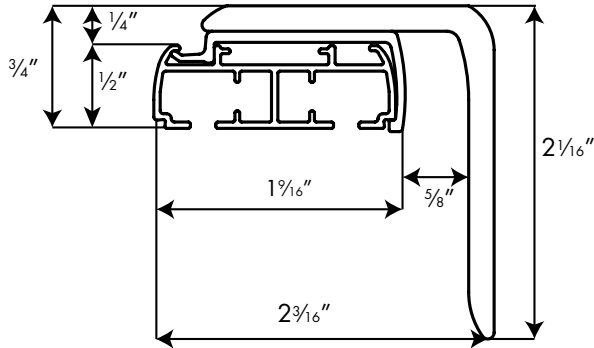

Two channel tracks are used for:
2 panel side stack
4 panel split stack

Mounting Dimensions

Minimum height required for outside mounting: 2 1/16"

Extension Bracket projects back of bracket 2 5/8" from wall

Three Track System

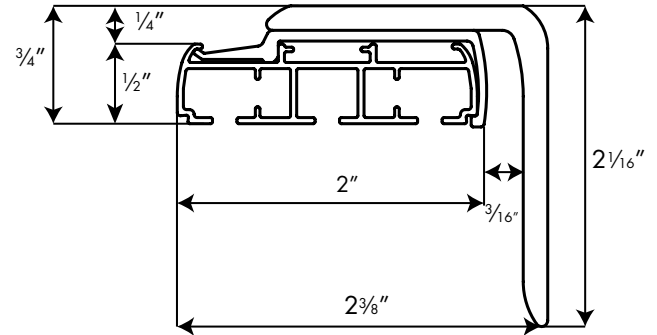

Three channel tracks are used for:
3 panel side stack
Not Available for split stack

Mounting Dimensions

Minimum height required for outside mounting: 2 1/16"

Extension Bracket projects back of bracket 2 3/16" from wall

Four Track System

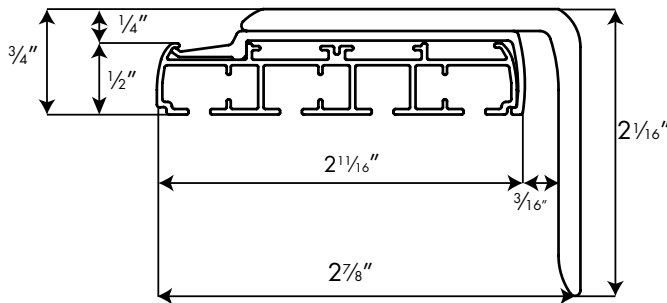

Four channel tracks are used for:
4 panel side stack
6 panel split stack

Mounting Dimensions

Minimum height required for outside mounting: 2 1/16"

Extension Bracket projects back of bracket 1 1/16" from wall

Five Track System

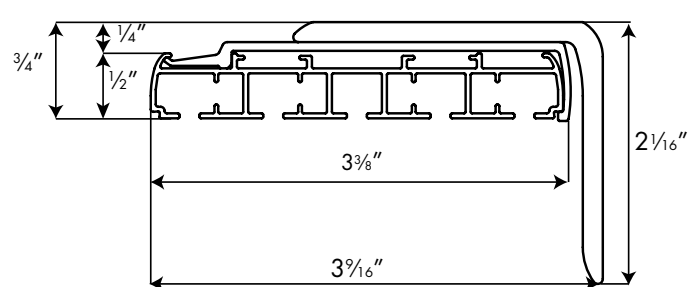

Five channel tracks are used for:
5 panel side stack
8 panel split stack

Mounting Dimensions

Minimum height required for outside mounting: 2 1/16"

Extension Bracket projects back of bracket 1 7/16" from wall

For outside mount brackets, Spacer blocks are available at 1/16" increments, up to two. Add to overall projection.
Example: For a four panel track, take 2 7/8" plus 1/16"

Color Lux® Panel Track Shades

SPECIFICATIONS

Inside Mount Hardware Profiles

Five separate panel track profiles are available depending on the number of panels ordered.

Two Track System

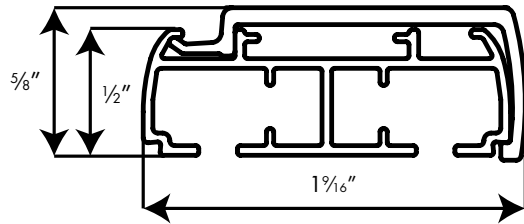

Two channel tracks are used for:
 2 panel side stack
 4 panel split stack

Mounting Dimensions
Minimum depth for flush inside mount: 1 1/16"
Minimum depth required for shallow mounting: 1 1/4"

Three Track System

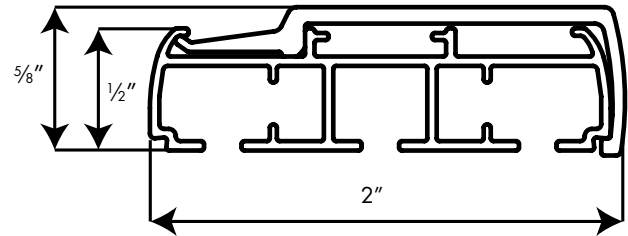

Three channel tracks are used for:
 3 panel side stack
 Not available for split stack

Mounting Dimensions
Minimum depth for flush inside mount: 2"
Minimum depth required for shallow mounting: 1 7/16"

Four Track System

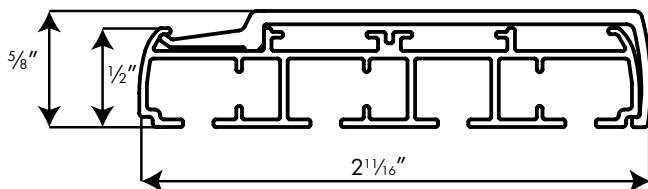

Four channel tracks are used for:
 4 panel side stack
 6 panel split stack

Mounting Dimensions
Minimum depth for flush inside mount: 2 11/16"
Minimum depth required for shallow mounting: 2 1/16"

Five Track System

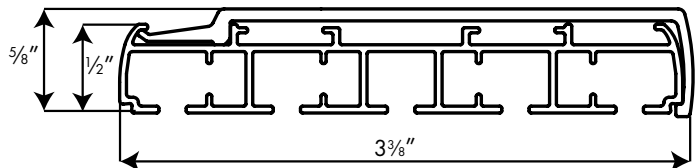

Five channel tracks are used for:
 5 panel side stack
 8 panel split stack

Mounting Dimensions
Minimum depth for flush inside mount: 3 3/8"
Minimum depth required for shallow mounting: 2 1/4"

COLORLUX® PANEL TRACK SHADES

COLOR LUX[®]

Custom Graphics



Color Lux® Custom Graphic Shades

CELLULAR SHADE FEATURES & GENERAL INFORMATION

COLORLUX® CUSTOM GRAPHICS

Custom Graphics

With Custom Graphics, you can print anything on a Cellular Shade. From logos to personal photos, theme room graphics or advertising for your storefront, anything you envision can be featured on a Custom Graphics Cellular Shade.

Hardware | Mounting | Finished Dimensions

See Page 18

Available Fabrics

Custom Graphics are available with the following fabrics:

- Premiere 1/2" and 3/4" Light Filtering Fabrics
- Premiere 1/2" and 3/4" Blackout Fabrics

Custom Graphics can work for any window.

Advertising and Store Identification

Contact local businesses and explain how you can to turn their window space into advertising!

Decorative and Personal Photos

Customers can now convert their special photos into a highly personalized room!

Printing Information and Options

Custom Graphics will look different from fabric to fabric. The color vibrancy on cellular shades will be muted due to the density of the fabrics and the printing process.

To view the color differences on Cellular Shades, visit the Custom Graphic section of the Comfortex Dealers website.

Single Sided Printing:

Cellular Custom Graphics are available as single-sided only. Double-sided graphics are not available.

You can choose to have Side A face the room side or the street side.



Side A Shows Printed Image



Side B White Fabric



Color Lux® Custom Graphic Shades

ROLLER SHADE FEATURES & GENERAL INFORMATION

Print Photos, Logos, Artwork, Advertisements and More on Color Lux® Roller and Panel Track Shades!

With Color Lux® Custom Graphics you can print literally anything on a Color Lux® Roller or Panel Track Shade. From logos and advertisements for a store front, to personal photos and theme room graphics, virtually anything you imagine can be featured on a Color Lux® Roller or Panel Track Shade.

Color Lux® Custom Graphics are also available on Cellular Shades. See the **Comfortex Cellular Shade Collection Manufacturer's Price List and Reference Guide** for more information.



Side A
Shows Printed Image

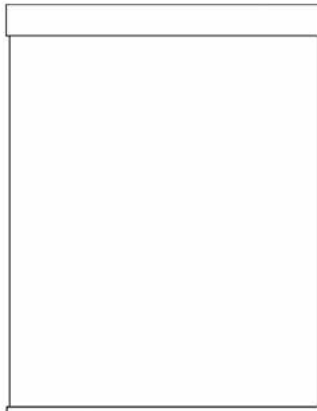

Side B
White Fabric

Single Sided Printing:

- Select a Roller or Panel Track Shade.
- Color Lux® Roller Custom Graphics Shades are available on Classic Duck Light Filtering, Classic Duck Blackout and 5% Screen.
- (5% Screen is only available with Custom Graphic Shades)
- Use the Color Lux Custom Graphics Grids on pages 116 and 117.
- A Color Lux® solid color may be selected for the background color of your shade.
- You can choose to have Side A face the room side or the street side.
- Use the Color Lux® Custom Graphics Order Form

Please Note: When ordering a Color Lux® Panel Track System Shade with a custom graphic, the custom graphic will not line up. The fabric used on Color Lux® Panel Track Shades will be printed at the total width and length specified for the complete system and then will be cut into the number of panels specified. **The pattern on the adjacent panels will overlap by 1½”.**



Side A
Shows Printed Image

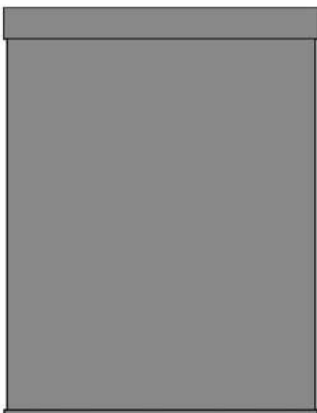

Side B
Solid Printed Color ONLY
(No Graphics)

Double Sided Printing -

Roller Shades on 5% Screen Fabric Only:

- Double sided printing is available only with Roller Shades.
- Double sided printing is only available on 5% Screen Fabric.
- Add the 40% Surcharge to the Standard Rectangular price found on page 117 plus desired hardware options.
- Side A can be any custom graphic.
- Side B can only be a Color Lux® solid color (NO GRAPHICS).
- You can choose to have Side A face the room side or the street side.
- A Color Lux® solid color may be selected for the background color of your shade.
- Use the Color Lux® Custom Graphics Roller Shade Order Forms.

Color Lux® Custom Graphic Shades

ROLLER SHADE FEATURES & GENERAL INFORMATION

COLORLUX® CUSTOM GRAPHICS

How to order Color Lux® Custom Graphic Shades

STEP 1. FAX OR E-MAIL YOUR ORDER

Fax the appropriate Color Lux® Custom Graphics order form (Roller, Panel Track or Cellular) located on comfortex.com/comfortex-dealers to (800) 336-4580. Or e-mail the order form to customercare@comfortex.com. Upon receipt and review of your order, you will receive a work order confirmation number from Comfortex. Please be sure to reference this number when submitting your artwork in Step 2.

STEP 2. SOURCE AND SEND YOUR GRAPHIC

Source your graphic from a stock photo site such as www.istockphoto.com or use your own high resolution photography. Send your files via e-mail to: customgraphics@comfortex.com OR ship a CD/portable media containing your graphics to:

Color Lux® Custom Graphics
 Comfortex Window Fashions
 21 Elm Street
 Maplewood, New York 12189

Using Online Stock Agencies for Graphics for Your Shades

Sometimes, finding the right graphic or photograph to fit your shade size, shape, or content can be challenging. Fortunately, many web sites offer a great solution. Online stock agencies allow you to purchase reasonably priced, royalty-free digital illustrations, graphics, photographs, patterns, and more in thousands of different subject areas. Some of the more popular sites include:

- thinkstock.com
- istockphoto.com
- veer.com
- shutterstock.com
- gettyimages.com
- 123rf.com
- photosearch.com

Using these sites is easy, simply follow these steps:

Step 1. Create an account and search for your image (i.e. apples).

Step 2. Select, purchase, and download the image you like. You may be given a choice of sizes, so take care to select an option large enough for your needs. Be sure to include the Work Order Confirmation Number received from Comfortex Customer Service with your graphic files.

STEP 3. APPROVE YOUR PROOF

The Color Lux® Custom Graphic Team will email a PDF proof of your shade order which must be reviewed and approved for production to begin. Once the artwork is approved, it will take 2 weeks for your order to be printed, assembled, and shipped.

Color Lux® Graphic File Specifications Preferred Formats

- Vector files/Adobe Illustrator (AI or EPS)
Please convert all typography to paths prior to submitting your vector artwork.
- TIFF, JPG/JPEG, or Adobe Photoshop (PSD) files with a minimum resolution of 100 pixels per inch at 100% size. For example, a shade measuring 30" x 40" should be supported by a graphic measuring at least 3000 x 4000 pixels.
- Adobe Acrobat (PDF) files created in "Press Quality" or "High Quality Print" with a minimum resolution for all raster elements of 100 pixels per inch at 100% size.

Graphics optimized for, or harvested from the internet are, in general, not suitable for reproduction onto shades.

Comfortex will seek to verify ownership and rights to reprint for all images showcasing copyrighted material.

Questions? Please contact Comfortex Customer Care with all questions regarding Color Lux® Custom Graphic Orders.

5% Screen Fabric Properties

5% Screen		Optical Properties		Thermal Properties		
		OF	TV	RS	TS	AS
Composition: 70% PVC	Chalk	5%	13%	68%	17%	15%
30% PES	Phthalate Free	Formaldehyde Free				
Weight: 410 g/m2	Lead Free	GreenGuard® Indoor Air Quality Certified				
UV Blockage: 95%	Zero VOC	Oeko-Tex Standard 100 Certified				
		Fire Rating: NFPA 701-10 TM #1				

Color Lux Custom Graphics
Skyline Standard Roller Shade

GRID 26 Classic Duck Light Filtering

COLORLUX® CUSTOM GRAPHICS

		Width In Inches																				
		24	30	36	42	48	54	60	66	72	78	84	90	96	102	106	112	118	124	130	136	144
Length In Inches	36	295	327	363	404	449	497	553	622	691	775	883	972	1046	1131	1220	1247	1485	1621	1769	1934	2110
	42	301	336	373	415	461	511	567	641	712	796	905	995	1074	1162	1253	1278	1526	1664	1821	1983	2169
	48	312	346	384	427	474	527	581	656	730	817	929	1023	1103	1191	1288	1312	1566	1708	1866	2038	2223
	54	322	353	392	436	484	536	598	673	748	836	953	1046	1133	1224	1321	1349	1605	1753	1913	2090	2282
	60	327	363	404	448	497	552	612	691	769	859	976	1072	1159	1251	1351	1378	1645	1796	1962	2140	2308
	66	336	372	414	459	510	565	626	705	785	879	998	1101	1186	1282	1386	1416	1686	1840	2008	2194	2339
	72	343	383	422	472	522	578	642	725	805	900	1025	1124	1217	1312	1421	1447	1726	1885	2054	2247	2374
	78	352	389	435	480	532	591	656	741	822	924	1046	1150	1243	1344	1449	1481	1766	1926	2104	2256	2578
	84	360	398	441	490	544	607	673	756	842	942	1071	1180	1273	1376	1483	1514	1805	1972	2032	2263	2656
	90	368	408	453	502	558	619	686	775	860	964	1093	1204	1302	1429	1531	1547	1845	2016	2076	2282	2737
	96	376	417	462	516	570	631	700	793	876	983	1119	1232	1329	1490	1568	1581	1887	2059	2121	2545	2819
	102	388	431	476	529	586	652	725	817	907	1005	1144	1258	1357	1530	1600	1628	1944	2121	2369	2622	2903
	108	394	439	487	538	600	666	738	832	926	1026	1165	1282	1386	1538	1652	1677	2002	2184	2441	2700	2990
	114	403	446	495	550	612	679	753	850	945	1046	1191	1308	1417	1574	1701						
120	412	456	507	563	625	692	769	867	964	1067	1214	1336	1443	1600	1764							
126	419	466	518	575	635	707	782	884	982	1090	1238	1361	1475	1636	1786							
132	431	476	529	586	650	723	800	901	1002	1112	1263	1388	1502	1669	1887							
138	439	485	537	598	661	736	816	919	1023	1133	1288	1418	1531	1695	1920							
144	446	493	548	611	674	750	831	938	1041	1153	1312	1445	1564	1763	1972							

Classic Duck Light Filtering: Minimum standard shade size is 12" x 12". Maximum shade width is 106" and it can be railroaded to a maximum width of 144" and a maximum length of 108". Double sided printing is not available.

GRID 27 Classic Duck Blackout

Color Lux Custom Graphics
Skyline Standard Roller Shade

		Width In Inches																				
		24	30	36	42	48	54	60	66	72	78	84	90	96	102	106	112	118	124	130	136	144
Length In Inches	36	327	364	404	448	498	552	613	691	768	862	978	1079	1160	1255	1353	1384	1648	1801	1965	2148	2340
	42	335	373	414	461	512	568	630	712	789	885	1004	1105	1193	1290	1391	1421	1694	1846	2021	2201	2409
	48	345	383	428	474	525	585	646	728	810	907	1030	1133	1225	1324	1430	1458	1736	1897	2071	2260	2470
	54	358	392	435	484	538	596	662	746	829	929	1060	1160	1259	1358	1466	1499	1783	1946	2123	2318	2633
	60	364	404	448	497	552	612	679	768	853	953	1083	1190	1286	1388	1501	1529	1825	1994	2177	2375	2807
	66	373	413	459	510	565	626	696	783	871	977	1109	1221	1317	1423	1538	1569	1875	2042	2228	2532	2992
	72	382	427	471	524	577	642	713	803	893	997	1139	1247	1349	1458	1577	1604	1915	2092	2281	2700	3190
	78	391	432	483	532	591	656	728	824	913	1025	1160	1277	1380	1490	1608	1644	1961	2140	2432	2879	3401
	84	398	442	489	543	604	673	746	840	934	1045	1189	1309	1415	1524	1646	1681	2004	2188	2593	3067	3625
	90	410	453	502	558	618	687	761	860	956	1069	1214	1336	1444	1587	1701	1718	2051	2331	2765	3269	3864
	96	417	462	515	572	634	700	776	878	973	1091	1242	1367	1476	1656	1741	1754	2095	2485	2947	3485	4119
	102	432	477	529	587	651	725	805	907	1008	1193	1358	1492	1612	1816	1901	2001	2390	2835	3362	3976	4700
	108	437	488	539	598	666	737	819	925	1027	1219	1387	1523	1646	1827	1963	2133	2547	3022	3585	4238	5011
	114	448	494	549	611	679	753	836	943	1048	1160	1324	1450	1571	1748	1885						
120	457	507	563	625	693	768	853	964	1069	1185	1347	1483	1602	1776	1957							
126	466	518	574	639	705	784	868	981	1089	1210	1375	1511	1637	1816	1982							
132	477	529	587	651	721	802	888	1000	1111	1233	1401	1542	1666	1853	2022							
138	488	537	596	664	735	818	906	1022	1133	1259	1430	1573	1701	1881	2062							
144	494	547	608	678	749	833	924	1041	1155	1281	1458	1604	1736	1956	2104							

Classic Duck Blackout: Minimum standard shade size is 12" x 12". Maximum shade width is 106" and it can be railroaded to a maximum width of 144" and a maximum length of 108". Double sided printing is not available.

Color Lux Custom Graphics for Panel Track Shades

Available on Classic Duck Light Filtering, Classic Duck Blackout, and 5% Screen (5% Screen is only available with Custom Graphics shades) See page 107 for price grids. Add 25% to Standard Rectangular price plus desired upgrades.

Color Lux Custom Graphics for Highlights Valance

Not available with the Keystone Option. Available on Classic Duck Light Filtering, Classic Duck Blackout, and 5% Screen (5% Screen is only available with Custom Graphics shades). See page 108 for price grids. Add 25% to Standard Rectangular price.

Color Lux Custom Graphics
Skyline Standard Roller Shade

GRID 28

5% Screen

COLORLUX® CUSTOM GRAPHICS

		Width In Inches																				
		24	30	36	42	48	54	60	66	72	78	84	90	96	102	108	112	118	124	130	136	144
Length In Inches	36	363	404	448	497	553	613	681	767	853	956	1086	1198	1288	1393	1502	1537	1830	1999	2181	2384	2598
	42	372	414	460	511	569	630	699	790	876	982	1114	1226	1324	1432	1544	1577	1880	2049	2243	2443	2674
	48	383	425	475	526	583	649	717	809	899	1007	1143	1258	1360	1469	1587	1618	1927	2105	2299	2509	2741
	54	398	435	483	537	597	662	735	829	921	1031	1176	1288	1397	1508	1627	1664	1979	2160	2357	2573	2922
	60	404	448	497	551	613	679	754	853	946	1058	1202	1321	1427	1541	1666	1697	2026	2213	2417	2637	3116
	66	414	458	510	566	628	695	773	869	966	1084	1231	1356	1462	1580	1707	1742	2081	2266	2473	2810	3322
	72	424	474	523	582	640	712	791	892	991	1107	1264	1384	1498	1618	1751	1781	2125	2322	2532	2997	3541
	78	434	480	536	590	656	728	809	915	1014	1137	1288	1417	1532	1654	1785	1825	2177	2375	2700	3195	3775
	84	442	491	543	603	671	747	829	932	1037	1160	1320	1453	1571	1692	1827	1865	2224	2428	2878	3405	4024
	90	455	503	557	619	686	763	844	955	1061	1186	1347	1483	1603	1762	1888	1907	2276	2588	3069	3629	4290
	96	462	513	572	635	704	777	862	975	1080	1211	1379	1518	1639	1838	1933	1947	2325	2759	3271	3869	4572
	102	480	530	587	652	722	804	893	1007	1119	1324	1508	1656	1789	2016	2110	2222	2652	3146	3732	4413	5217
	108	485	541	599	663	740	819	909	1027	1140	1353	1539	1690	1827	2028	2179	2368	2828	3355	3979	4705	5562
	114	497	549	609	678	754	836	928	1047	1163	1288	1469	1610	1743	1940	2092						
120	507	563	625	694	770	853	946	1070	1186	1315	1495	1646	1778	1972	2173							
126	517	574	638	709	783	870	964	1089	1209	1343	1527	1677	1817	2016	2200							
132	530	587	652	722	800	890	985	1110	1234	1369	1555	1712	1850	2056	2245							
138	541	596	662	737	816	908	1005	1134	1258	1397	1587	1746	1888	2088	2289							
144	549	607	675	752	831	925	1025	1156	1282	1422	1618	1781	1927	2171								

5% Screen: Minimum standard shade size is 12" x 12". Maximum shade width is 120" and can be railroaded to a maximum width of 144" with a maximum length of 108". 5% Screen is only available for Color Lux Custom Graphics shades. Double Sided printing is only available on 5% Screen.

Head Rail Options and Surcharges

Section 1 & 2	Available: Designer Cassette (All), Cordless Deco-Bar, Fascia (All), Motorization, PowerTouch Rechargeable, Standard Roller, and All Skyline Hardware
Section 3	Available: Standard Roller, Standard Skyline Roller, 4" Fascia, and 4" Skyline Fascia with Cord Loop (Dual Roller Not Available)
Section 4	Available: Standard Skyline Roller Only (Dual Roller Not Available)

Roller Only Options

Skyline Clutch (White, Ivory, Black)	No Additional Surcharge
Skyline Clutch (Satin Nickel and Bronze)	\$28
Skyline Dual Roller (Price two separate shades, then add surcharge)	\$28
Cordless with White, Ivory and Black Deco-Bar	\$42
Cordless with Bronze and Satin Nickel Deco-Bar	\$63
NEW FeatherTouch™ Cordless with EZ Mount Hardware in White and Black	\$42
NEW FeatherTouch™ Cordless with EZ Mount Hardware in Designer Nickel	\$63
Spring Assist for Shades over 84" x 84" (White or Black Clutch)	\$130
Scotchgard™ Stain Protection for Roller Shades	\$38

Tube Information for Clutch Operated Shades Only

- **Section 1:** Shades to the left of the dashed line requires a 1" tube/SL10 clutch
- **Section 2:** Shades to the right of the dashed line requires a 1½" tube/SL10 clutch
- **Section 3:** Shades in the blue section requires a 2" tube/SL20 clutch.
- **Section 4:** Shades in the orange section requires a 2½" tube/Galaxy 200 clutch

FeatherTouch Cordless is NOT Available on 5% Screen.

Designer Cassette and Fascia Options

	24	30	36	42	48	54	60	66	72	78	84	90	96	102	108	114	120
White, Ivory, Black, Satin Nickel, and Oil Rubbed Bronze Includes Smooth Face and Insert Strip	78	84	90	97	103	111	119	126	133	128	135	147	152	156	162	185	208
4" Skyline Fascia	64	70	72	74	84	97	106	117	128	137	149	162	169	179	191	201	210
Cordless, FeatherTouch™ & Retractable Cord with Cassette	Add \$42 PLUS the Designer Cassette Surcharge for all operating options																

Highlights Cornice Valance

	24	30	36	42	48	54	60	66	72	78	84	94	96	102	108	114	120	132	144
6" & 8" Highlights Cornice Valance (No Keystone)	147	163	178	194	210	219	231	242	253	263	275	293	Requires Keystone. See pricing below						
6" & 8" Highlights Cornice Valance (with ONE Keystone)	198	214	230	244	261	271	282	295	303	315	326	345	349	360	370	381	393	409	419
10" - 16" Highlights Cornice Valance (No Keystone)	198	220	241	262	284	296	312	326	341	355	372	395	Requires Keystone. See pricing below						
10" - 16" Highlights Cornice Valance (with ONE Keystone)	267	289	311	329	352	366	381	398	409	425	441	465	471	486	500	515	530	552	566

Motorization: Available with Designer Cassette, 4" Skyline Fascia, and Standard Roller

Add Motorization surcharges to base shade price, plus desired hardware options	Reference
PowerTouch Rechargeable	\$118 per shade pg. 93
Simplicity Wave	\$121 per shade pg. 90
Simplicity Rechargeable & Non-Rechargeable Motorization	\$319 per shade pg. 95
Simplicity Rechargeable Heavy Duty Motorization	\$434 per shade pg. 96
Simplicity Low Voltage Hard Wired Transformer	\$74 per transformer pg. 98
Simplicity 5 Channel Remote	\$41 per remote pg. 100
Simplicity 6 Channel Timer Remote	\$67 per remote pg. 100
Simplicity 14 Channel Remote	\$67 per remote pg. 100
Simplicity Smart Controller	\$336 per controller pg. 35
NEW EZ Charge Wand and Receiver	\$56/\$31 each pg. 97
Solar Panel	\$105 per panel pg. 96
Telescoping Wand for Simplicity Wave	\$32 per wand pg. 90
Charger for Simplicity Rechargeable Motor	\$28 per charger pg. 95
Charger for Heavy Duty Rechargeable Motor	\$59 per charger pg. 96

Cordless Specifications:

Minimum width is 15½"; Maximum Width is 96"; Maximum Length is 96"

FeatherTouch Cordless Specifications Duck Light Filtering:

Minimum width is 19"; If width is 30" or less, then maximum length is 61". If width is over 30", then maximum length is 84".

FeatherTouch Cordless Specifications Duck Blackout:

Minimum width is 17"; If width is 26" or less, then maximum length is 53". If width is over 26", then maximum length is 84".





COLOR LUX® SHANGRI-LA® SHEER HORIZONTAL SHADINGS



COLORLUX® SHANGRI-LA SHEER SHADINGS

- Color Lux Sheer Shadings are a window shading of unique beauty and performance for the finishing touch to a beautiful window and room.
- Horizontal fabric vanes float between two layers of soft, knitted fabric sheers to soften your view outside.
- Color Lux Sheer Shadings are available to widths of 120" and drops to 132", Color Lux Solid Color Sheer Shadings are available to widths of 96" and drops to 96", both provide visual elegance to the widest of windows.
- Color Lux Sheer Shadings are available in 3-inch vane widths in both light filtering and room darkening fabrics.
- The sophisticated 25 patterns of white on white Color Lux Printed Sheer Shadings is designed to flatter your decor.
- All Color Lux Sheer Shadings, printed and solid colors, will have fabric wrapped head rail and bottom rail.
- Vanes glide from open to closed to out of sight with elegant hardware.
- Choose from multiple hardware options to customize your shading: traditional cord loop, retractable cord, cordless PowerTouch with Touch and Go feature or Simplicity Integrated Rechargeable Motorization.
- Only the Omni-View cord system provides five distinctly different variations of vane position for numerous combinations of privacy, view and light control.
- Only with Color Lux Sheer Shadings, can you partially raise the shading with the fabric vanes in the open, view-through position so you keep your view and still feel the outdoor breeze.
- Create your customers own sophisticated look with the low light gap Designer Cassette Head Rail.
- Easy to install hardware and brackets allow for effortless installations and easy removal for cleaning.
- Color Lux Sheer Shadings may be ultrasonically or traditionally cleaned to stay bright and beautiful.
- A Limited Lifetime Warranty serves as a commitment to your satisfaction.

HARDWARE OPTIONS

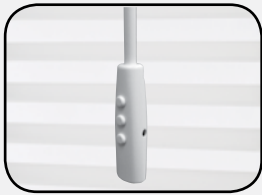

	Key Features	Color Options	Head Rail Size (Depth x Height)	Shade Size Available	More Information
Cord Loop 	<ul style="list-style-type: none"> • Cord Loop makes operation easy • Smooth & quiet operation • Braided cord loop is used to raise and lower the shading • Bead Cord is optional 	<ul style="list-style-type: none"> • Fabric Wrap is Standard • White • Ivory • Onyx Black • Oil Rubbed Bronze • Brushed Nickel 	Fabric Wrapped: 3¾" x 2¾"	Width: 12" to 120"* Length: 12" to 132"***	Page 128
Retractable Cord 	<ul style="list-style-type: none"> • Single Cord Design • Provides easy one hand operation • Maintains a consistent cord length • Enhances child and pet safety 	<ul style="list-style-type: none"> • White • Black • Bronze 	Fabric Wrapped: 3¾" to 2¾"	Width: 12" to 120"* Length: 12" to 132"***	Page 130
Cordless Shading 	<ul style="list-style-type: none"> • Cord Free • Roller catch mechanism in the head rail • Vanes easily adjusted into various positions 	<ul style="list-style-type: none"> • Clear handle • Bottom Rail is fabric wrapped 	Fabric Wrapped: 3¾" to 2¾"	Width: 20" to 84" Length: 18" to 96"	Page 132
12V Non-Rechargeable Simplicity Motorization 	<ul style="list-style-type: none"> • Raise & lower shade with click of a button • Great for large and hard to reach windows • Remote can operate multiple shades 	<ul style="list-style-type: none"> • Designer Cassette options • 5 Channel Black or White Remote • 6 Channel white Remote with timer 	Fabric Wrapped: 3¾" to 2¾"	Width: 14" to 120"* Length: 12" to 132"***	Page 138
7.4V Rechargeable Simplicity Motorization 	<ul style="list-style-type: none"> • Features a battery powered motor utilizing a rechargeable integrated battery pack • Raise & lower shading with click of a button • Great for large and hard to reach windows • Remote can operate multiple shades 	<ul style="list-style-type: none"> • Designer Cassette options • 5 Channel Black or White Remote • 6 Channel white Remote with timer • 14 Channel white Remote with timer 	Fabric Wrapped: 3¾" to 2¾"	Width: 19" to 120"* Length: 12" to 132"***	Page 140
7.4V Rechargeable PowerTouch 	<ul style="list-style-type: none"> • Raise & lower shading with push of a button • Eliminate the need to stand by the shading to operate; just touch and go • Favorite position button • Rechargeable battery with recharge port on pendant 	<ul style="list-style-type: none"> • Wand and pendant available in white or black 	Fabric Wrapped: 3¾" x 2¾"	Width: 18" to 120" Length: 12" to 132"	Page 136

* Maximum width of 120" IB, 119¾" OB

** Light Filtering 132", Room Darkening 122"

Color Lux® Shangri-La Sheer Horizontal Shadings

HARDWARE OPTIONS

	Key Features	Color Options	Hardware Size (Depth x Height)	Shade Size Available	More Information
<p>DoorStyles</p>  <p>(Printed Sheer ONLY)</p>	<ul style="list-style-type: none"> • Great option for narrow windows and doors • Does not raise/lower, articulate vanes only • No Pull cords • Secure to door with hold down brackets 	<ul style="list-style-type: none"> • Rails and end caps are coordinated to the fabric color 	<p>2" x 1/2"</p>	<p>Width: 6" to 72"</p> <p>Length: 12" to 72⁺"</p>	<p>Page 134</p>
<p>Highlights Cornice Valance</p> 	<ul style="list-style-type: none"> • Adds height to windows and hides hardware • Available as inside and outside mount • Easy to install 	<ul style="list-style-type: none"> • All Color Lux Roller Fabrics • All Envision Roller Fabrics 	<p>Width: 24" to 216"</p> <p>Height: 6"</p> <p>Returns: 1 1/2" to 6"</p>	<p>Varies by selected fabric</p> <p>Width: 12" to 94"</p>	<p>Page 62</p>

* Maximum length varies by width

Color Lux® Shangri-La Sheer Horizontal Shadings

FABRIC COLLECTIONS

Color Lux Printed Sheer Shadings are available with different fabric collections.

COLLECTION	3" Vanes
Light Filtering	•
Room Darkening	•

Please Note: Room Darkening fabrics are not blackout fabrics. Knitted fabric may experience minor weave variations due to heat, humidity and other room conditions. These variations can result in light bowing, puckering and dimpling of the Shangri-La material. This is considered normal and does not constitute a failure in either workmanship or materials. The possible variations are minor and have been shown through case study not to detract from the beauty of the product.

Color Lux® Shangri-La Sheer Horizontal Shadings

HARDWARE OPTION AVAILABILITY

Use this table to ensure your coordinating options and unique shapes are consistent with your product selections.

CORD LOOP	3" Vanes
Cord Loop	•
Cord Loop Two-On-One	•
RETRACTABLE CORD	
Retractable Cord	•
Retractable Cord Two-On-One	•
CORDLESS SHADING	
Cordless Shading	•
Cordless Shading Two-On-One	NA
SIMPLICITY MOTORIZATION	
Simplicity Motorization	•
Simplicity Motorization Two-On-One	•
SIMPLICITY RECHARGEABLE MOTORIZATION	
Simplicity Rechargeable	•
Simplicity Rechargeable Two-On-One	•
POWERTOUCH RECHARGEABLE MOTORIZATION	
PowerTouch Rechargeable	•
PowerTouch Rechargeable Two-On-One	•
DOORSTYLE	
DoorStyle Prints Only	•



Fabric Wrapped is Standard



Metallic Hardware Upgrades



*Bottom Rail Partly Opened
(Bottom Rail is always fabric wrapped)*



Bottom Rail Closed

Color Lux® Shangri-La Sheer Horizontal Shadings

SIZE STANDARDS



		Cord Loop	Retractable Cord	Cordless Shading
ALL FABRICS	Minimum Width	12"	12"	20"
	Minimum Length	12"	12"	12"

Light Filtering	Price Group	Page		Cord Loop	Retractable Cord	Cordless Shading
3" Vanes	29	126	Maximum Width & Length	120"* x 132"	120"* x 132"	84" x 96"

Room Darkening	Price Group	Page		Cord Loop	Retractable Cord	Cordless Shading
3" Vanes	30	126	Maximum Width & Length	120"* x 122"	120"* x 122"	84" x 96"

				Cord Loop	Retractable Cord	Cordless Shading
More Information On Page				Page 128	Page 130	Page 132

* Maximum width of 120" IB, 119¾" OB

SIZE STANDARDS



		Motorization	Motorization	Motorization	Two-On-One
		7.4V Rechargeable Simplicity	12V Non-Rechargeable Simplicity	7.4V Rechargeable PowerTouch	
ALL FABRICS	Minimum Width	19"	14"	18"	See Table Below ⁺
	Minimum Length	12"	12"	12"	12"

			Motorization	Motorization	Motorization	Two-On-One	
			7.4V Rechargeable Simplicity	12V Non-Rechargeable Simplicity	7.4V Rechargeable PowerTouch		
Light Filtering	Price Group	Page					
3" Vanes	29	126	Maximum Width & Length	120"* x 132"	120" x 132"	120"* x 132"	140" x 132"

			Motorization	Motorization	Motorization	Two-On-One	
			7.4V Rechargeable Simplicity	12V Non-Rechargeable Simplicity	7.4V Rechargeable PowerTouch		
Room Darkening	Price Group	Page #					
3" Vanes	30	126	Maximum Width & Length	120"* x 122"	12" x 122"	120"* x 122"	140" x 122"

		Motorization	Motorization	Motorization	Two-On-One
		7.4V Rechargeable Simplicity	12V Non-Rechargeable Simplicity	7.4V Rechargeable PowerTouch	
More Information On Page		Page 140	Page 138	Page 136	Page 131

* Maximum width of 120" IB, 119¾" OB

	Minimum Width	Hardware
TWO-ON-ONE HARDWARE⁺	24"	Cord Loop
	24"	Retractable Cord
	NA	Cordless
	28"	Simplicity Motorization
	38"	Simplicity Rechargeable
	36"	PowerTouch Rechargeable

Color Lux® Shangri-La Sheer Horizontal Shadings

SIZE STANDARDS



		DoorStyles	
ALL FABRICS <i>Printed Sheer Only</i>	Minimum Width	6"	
	Minimum Length	12"	

Light Filtering	Price Group	Page	DoorStyles	
3" Vanes <i>Printed Sheer Only</i>	31	127	Maximum Width & Length	72" x 96"*

Room Darkening	Price Group	Page	DoorStyles	
3" Vanes <i>Printed Sheer Only</i>	32	127	Maximum Width & Length	72" x 96"*

			DoorStyles	
More Information On Page			Page 134	

* Maximum length varies by width. Maximum length for doorstyles over 36" wide is 72".



COLORLUX® SHANGRI-LA SHEER SHADINGS

Color Lux® Shangri-La Sheer Horizontal Shadings

HARDWARE UPGRADE OPTIONS

LIFT SYSTEM	UPGRADES	ADD
Cord Loop	Bottom Up	Included
Retractable Cord	Bottom Up	\$102
Cordless Shading	Bottom Up	\$102

DESIGNER UPGRADE OPTIONS	UPGRADES	ADD
Add to Any Lift System Upgrade (Chart to the left)	Metallic Hardware	\$138
	Scotchgard Stain Protection	\$54
	Highlights Valance <i>See Page 62 For More Information</i>	

ADDITIONAL OPTIONS	UPGRADES	ADD
Add to Any Upgrade Above	Two-On-One Head Rail	Price as two shadings and add together.
Accessories	6 Foot Expandable Pole	\$62
	12 Foot Expandable Pole	\$75

Shangri-La Sheer Horizontal Shadings **Motorized** Hardware Upgrade Options

MOTORIZED	UPGRADES	ADD	
7.4V Rechargeable PowerTouch Motorization System	Rechargeable Integrated Battery Pack	\$179	For More Information Page 136
	Plug-In Charger for Rechargeable Li-Ion	\$42	
12V Non-Rechargeable Simplicity Motorization System	Motor and Battery Wand	\$485	For More Information Page 138
	48" Extension Wire	\$28	
	Single Unit DC Power Supply/Transformer	\$112	
7.4V Rechargeable Simplicity Motorization System	Motor and Integrated Battery Pack	\$485	For More Information Page 140
	Plug-In Charger for Rechargeable Li-Ion	\$42	
	7.4v Solar Panel	\$160	
Simplicity Systems Controllers	NEO Controller	\$510	For More Information Pages 144, 30 & 32
	NEO Application for Mobile Devices	FREE	
	Simplicity 5 Channel Remote	\$62	
	Simplicity 6 Channel Remote with Timer	\$102	
	Simplicity 14 Channel White Remote	\$102	
7.4V EZ Charge Extension Wand	Wall Mount Receiver Kit	\$31	For More Information Page 143
	Extendable Wand	\$56	
12V Low Voltage Hardwiring	9 Channel Wall Mount Transformer	\$400	For More Information Page 34

COLORLUX® SHANGRI-LA SHEER SHADINGS

Color Lux Shangri-La Sheer Horizontal Sheer Shading Pricing Examples

Two-On-One Pricing Example:

3" Light Filtering 42" x 60" Shadings:	\$1184.00 x 2 \$2368.00
Retractable Cord Upgrade:	\$102.00 x 2 \$204.00
Total List Price:	\$22572.00

Simplicity Rechargeable Motorization Pricing Example:

3" Light Filtering 42" x 60" Shade:	\$1184.00
Metallic Hardware Option	\$138
Simplicity Rechargeable Surcharge:	\$485.00
Charger for Rechargeable (required):	\$42.00
Simplicity Remote Control:	\$62.00
Total List Price:	\$1911.00

Color Lux® Shangri-La Sheer Horizontal Shadings

PRICING

3" Light Filtering Vanes

PRICE GROUP 29 Cord Loop

		Width In Inches												
		24	30	36	42	48	54	60	66	72	84	96	108	120
Length In Inches	36	682	766	857	936	1025	1115	1197	1286	1504	1689	1863	2262	2662
	42	719	811	901	1001	1095	1195	1286	1378	1606	1805	1991	2428	2864
	48	761	859	964	1060	1163	1265	1375	1483	1713	1918	2125	2602	3075
	54	793	900	1012	1123	1238	1346	1467	1590	1816	2033	2274	2848	3419
	60	829	952	1065	1184	1300	1434	1558	1690	1912	2163	2423	3043	3661
	66	867	996	1121	1247	1378	1517	1663	1797	2016	2299	2577	3235	3891
	72	901	1040	1176	1311	1455	1606	1753	1903	2125	2428	2729	3446	4160
	78	928	1077	1218	1368	1521	1679	1832	1992	2226	2552	2864	3620	4374
	84	967	1121	1268	1440	1599	1764	1936	2103	2341	2690	3020	3802	4589
	90	1008	1163	1327	1502	1676	1861	2027	2206	2454	2817	3170	4013	4853
	96	1045	1212	1382	1570	1753	1937	2120	2305	2569	2948	3321	4214	5104
	102	1198	1385	1577	1784	1972	2152	2405	2640	2822	3210	3581	4331	5215
	108	1261	1458	1663	1878	2070	2269	2528	2780	2974	3373	3770	4560	5347
114	1338	1547	1762	1991	2206	2412	2682	2947	3154	3581	3995	4837	5678	
120	1440	1657	1892	2133	2353	2577	2866	3154	3374	3834	4278	5177	6070	
126	1531	1764	2015	2270	2511	2747	3056	3367	3598	4089	4561	5517	6478	
132	1632	1880	2146	2419	2673	2933	3257	3587	3835	4355	4860	5881	6903	

3" Room Darkening Vanes

PRICE GROUP 30 Cord Loop

		Width In Inches												
		24	30	36	42	48	54	60	66	72	84	96	108	120
Length In Inches	36	750	843	943	1030	1128	1227	1317	1415	1654	1858	2049	2488	2928
	42	791	892	991	1101	1205	1315	1415	1516	1767	1986	2190	2671	3150
	48	837	945	1060	1166	1279	1392	1513	1631	1884	2110	2338	2862	3383
	54	872	990	1113	1235	1362	1481	1614	1749	1998	2236	2501	3133	3761
	60	912	1047	1172	1302	1430	1577	1714	1859	2103	2379	2665	3347	4027
	66	954	1096	1233	1372	1516	1669	1829	1977	2218	2529	2835	3559	4280
	72	991	1144	1294	1442	1601	1767	1928	2093	2338	2671	3002	3791	4576
	78	1021	1185	1340	1505	1673	1847	2015	2191	2449	2807	3150	3982	4811
	84	1064	1233	1395	1584	1759	1940	2130	2313	2575	2959	3322	4182	5048
	90	1109	1279	1460	1652	1844	2047	2230	2427	2699	3099	3487	4414	5338
	96	1150	1333	1520	1727	1928	2131	2332	2536	2826	3243	3653	4635	5614
	102	1318	1524	1735	1962	2169	2367	2646	2904	3104	3531	3939	4764	5737
	108	1387	1604	1829	2066	2277	2496	2781	3058	3271	3710	4147	5016	5882
114	1472	1702	1938	2190	2427	2653	2950	3242	3469	3939	4395	5321	6246	
120	1584	1823	2081	2346	2588	2835	3153	3469	3711	4217	4706	5695	6677	
122	1684	1940	2217	2497	2762	3022	3362	3704	3958	4498	5017	6069	7126	

COLORLUX® SHANGRI-LA SHEER SHADINGS

LIFT SYSTEM	UPGRADES	ADD	DESIGNER UPGRADE OPTIONS	UPGRADES	ADD
Cord Loop	Bottom Up	Included	Add to Any Lift System Upgrade (Chart to the left)	Metallic Hardware	\$138
Retractable Cord	Bottom Up	\$102		Scotchgard Stain Protection	\$54
Cordless Shading	Bottom Up	\$102		Highlights Valance <i>See Page 62 For More Information</i>	
ADDITIONAL OPTIONS	UPGRADES	ADD	Add to Any Upgrade Above		
	Two-On-One Head Rail	Price as two shadings and add together.			
Accessories	6 Foot Expandable Pole	\$62			
	12 Foot Expandable Pole	\$75			
MOTORIZATION					MORE INFO
For motorization surcharges and options refer to page 125.					Pg 125

Shadings wider than 96": Shadings over 96" in width may require additional fabrication and delivery time.

Color Lux® Shangri-La Sheer Horizontal Shadings

PRICING

3" Light Filtering Vanes

White-on-White Color Lux Prints Only

PRICE GROUP 31 DoorStyles*

		Width In Inches											
		6	12	18	24	30	36	42	48	54	60	66	72
Length In Inches	12	582	595	612	625	696	784	842	859	953	971	992	1177
	18	583	602	617	636	714	804	870	889	988	1014	1035	1240
	24	585	609	627	649	728	827	893	919	1029	1053	1081	1295
	30	591	614	638	660	744	845	922	949	1066	1097	1124	1351
	36	594	617	648	688	769	861	941	1031	1120	1202	1291	1513
	42	636	668	697	723	815	905	1005	1100	1200	1291	1385	1614
	48	656	692	788	766	864	968	1066	1168	1274	1382	1489	1720
	54	671	712	754	796	904	1016	1129	1243	1354	1474	1598	1827
	60	693	736	779	833	956	1070	1189	1308	1441	1565	1698	1922
	66	733	779	831	870	1001	1125	1253	1385	1524	1671	1805	2026
	72	754	806	861	905	1045	1181	1317	1462	1614	1762	1912	2136
	78	769	832	889	933	1081	1223						
	84	796	859	922	971	1125	1276						
90	817	887	955	1013	1168	1332							
96	842	914	987	1049	1218	1389							

3" Room Darkening Vanes

White-on-White Color Lux Prints Only

PRICE GROUP 32 DoorStyles*

		Width In Inches											
		6	12	18	24	30	36	42	48	54	60	66	72
Length In Inches	12	640	655	673	688	766	862	926	945	1048	1068	1091	1295
	18	641	662	679	700	785	884	957	978	1087	1115	1139	1364
	24	644	670	690	714	801	910	982	1011	1132	1158	1189	1425
	30	650	675	702	726	818	930	1014	1044	1173	1207	1236	1486
	36	653	679	713	757	846	947	1035	1134	1232	1322	1420	1664
	42	700	735	767	795	897	996	1106	1210	1320	1420	1524	1775
	48	722	761	867	843	950	1065	1173	1285	1401	1520	1638	1892
	54	738	783	829	876	994	1118	1242	1367	1489	1621	1758	2010
	60	762	810	857	916	1052	1177	1308	1439	1585	1722	1868	2114
	66	806	857	914	957	1101	1238	1378	1524	1676	1838	1986	2229
	72	829	887	947	996	1150	1299	1449	1608	1775	1938	2103	2350
	78	846	915	978	1026	1189	1345						
	84	876	945	1014	1068	1238	1404						
90	899	976	1051	1114	1285	1465							
96	926	1005	1086	1154	1340	1528							

ADDITIONAL OPTIONS

Scotchgard Stain Protection	\$54
Six Foot Operator Pole	\$62
Twelve Foot Operator Pole	\$75

*Rails and endcaps on Shangri-La DoorStyles Shadings are coordinated to the fabric color. Hardware used on DoorStyles may not match standard shadings.

Color Lux® Shangri-La Sheer Horizontal Shadings

CORD LOOP SHADING HARDWARE SYSTEM | DESIGNER CASSETTE HEAD RAIL



Fabric Wrapped

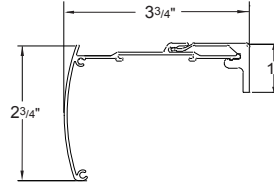

Fabric Wrapped Designer Cassette Head Rail

- Depth of rail and bracket: 3 3/4"
- Height of rail: 2 3/4"
- Height of bracket: 1"



Bottom Rail Partly Opened



Bottom Rail Closed

(Bottom Rail is always fabric wrapped)

Hardware Features	
Standard Designer Cassette	Fabric Wrapped Designer Cassette is standard. Head rail endcap is fabric covered
Bottom Rail Color	Bottom rail is fabric wrapped with white end caps.
Head Rail Upgrades <i>(Bottom rail is always fabric wrapped)</i>	
Designer Metallic Upgrade (Smooth Face)	<ul style="list-style-type: none"> • Oil Rubbed Bronze • Onyx Black • Brushed Nickel
Mounting Dimensions	
Designer Cassette Head Rail	
Minimum Shallow Mount	1"
Minimum Flush Inside Mount (including brackets)	3 3/4"
Minimum Outside Mount	1"
Minimum Side Mount	1 1/4"
Width Side Mount	48" Max width side mount
Finished Dimensions	
Inside Mount	
	<ul style="list-style-type: none"> • Fabric will measure ordered width less: 1" • Head rail* will measure ordered width less: 3/16"
Side (End) Mount	
	<ul style="list-style-type: none"> • Fabric will measure ordered width less: 1 1/2" • Head rail* will measure ordered width less: 1 1/16"
Outside Mount	
	<ul style="list-style-type: none"> • Fabric will measure ordered width less: 5/8" • Head rail* will measure ordered width plus: 3/16"
Exact (End Cap to End Cap) Mount	
	<ul style="list-style-type: none"> • Fabric will measure ordered width less: 1 3/16" • Head rail* will measure ordered width
* Head rail measurements include endcaps. Width and length measurements may vary +/- 1/8"	

Please Note: Once ordered and manufactured, the width of the Shangri-La fabric cannot be altered. Comfortex makes deductions to the width depending on the type of mounting indicated. For all mounting types, fabric will measure exactly the length ordered when the vanes are in the opened position.

Color Lux® Shangri-La Sheer Horizontal Shadings

CORD LOOP SHADING HARDWARE SYSTEM | DESIGNER CASSETTE HEAD RAIL

Head Rail Options

Fabric Wrapped Designer Cassette Head Rail is standard. End caps of the head rail are fabric covered.

Designer Metallic Upgrade is available. Colors available: Oil Rubbed Bronze, Onyx Black and Brushed Nickel. Bottom rail is always fabric wrapped.

Cord Type and Color

White, black or bronze loop cord coordinates with your hardware choice. Bead cord is optional in white, bronze, black or steel. Cord tensioners match your hardware choice (white, black or bronze).

Reverse Roll

The braided cord does not have a reverse roll stop. If a shading with the Designer Cassette hardware is raised above 24" in the reverse roll mode, there is a possibility of the fabric rubbing on the head rail. Comfortex reserves the right NOT to warrant wear and tear of fabric if damaged by roll-up in excess of 24".

Length Considerations with Shangri-La Shadings

Comfortex will fabricate your Shangri-La Window Shading to the length ordered, when the vanes are in the open position (Figure A).

- When the vanes are rotated to the closed position, the shading will become slightly longer.
- When closed on an inside mount, the shading will be slightly longer than ordered length.
- Rotating the vanes closed will cause the bottom rail to touch the window sill, before it begins to raise.

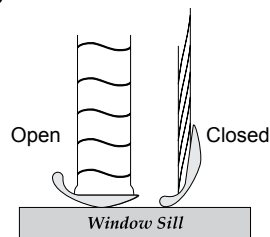

Figure A

Side By Side Alignment

When Shangri-La Window Shadings are installed side-by-side, vane alignment can be guaranteed within 1/4" only if:

- The shadings are the same color and ordered at the same time.
- The sum total of the widths of all shadings needing alignment is less than 118".

Side-by-side lineup is specified when the order is placed.

Omni-View System

Shangri-La Shadings feature the Omni-View™ Cord System. The Omni-View System provides the ability to manipulate the shading into various viewing positions. There are variations in visibility through the shadings when the vanes are tilted to their maximum open positions. The following five modes can be obtained with standard shading operation when viewing the shading at eye level.

- **Closed top, open bottom:** By partially lowering the shading from the fully raised position, the upper portion of your window will become semi-opaque while allowing a clear view below.
- **Fully private:** When lowered completely, Shangri-La provides complete privacy and softly diffused light.
- **Partially open:** Opening Shangri-La slightly will gradually increase the level of light and allow varying levels of view through.
- **View-through when lowered:** By completely opening the vanes, Shangri-La provides a softened, veiled view to the outside.
- **View-through when raised:** From the open or view-through position, continuing to pull down on the back of the cord will raise the fabric allowing a clear view outside from below, and a veiled view above. This exclusive feature allows Shangri-La to be raised up to 24" in this mode.
- Comfortex recommends that you **do not** raise the shading more than 24" off the sill in the view-through when raised mode. Refer to warranty section below for more information.
- Omni-View is only available with Shangri-La Shadings built with braided cord loop.

Cord Information For Shangri-La Shadings

A braided cord loop is used to raise and lower the shading. White, black or bronze loop cord matches your hardware choice. Cord tensioner will match the hardware color.

Bead cord is available in black, white, bronze, nickel and steel.

The cord loop will measure the length indicated below unless otherwise specified.

Shade Length	Standard Loop
16" to 26 ⁷ / ₈ "	1' (12")
27" to 39 ⁷ / ₈ "	2' (24")
40" to 59 ⁷ / ₈ "	3' (36")
60" to 83 ⁷ / ₈ "	4' (48")
84" to 107 ⁷ / ₈ "	5' (60")
108" and greater	6' (72")

Maximum cord length is 15 feet. Polyester cord can be ordered in custom lengths in 1 foot increments only.

Braided Cord Loop Warranty Information

The shadings built with a braided cord loop do not have a reverse roll stop. If a shading is raised above 24" in the reverse roll mode, there is a possibility of the fabric rubbing on the head rail. Comfortex reserves the right NOT to warrant wear and tear of fabric if damaged by roll-up in excess of 24".

Color Lux® Shangri-La Sheer Horizontal Shadings

RETRACTABLE CORD HARDWARE SYSTEM | DESIGNER CASSETTE HEAD RAIL



Fabric Wrapped

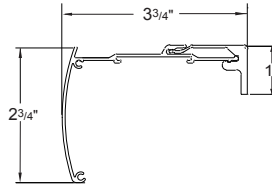

Fabric Wrapped Designer Cassette Head Rail

- Depth of rail and bracket: 3 3/4"
- Height of rail: 2 3/4"
- Height of bracket: 1"

Hardware Features	
Standard Designer Cassette	Fabric Wrapped Designer Cassette is standard. Head rail endcap is fabric covered
Bottom Rail Color	Bottom rail is fabric wrapped with white end caps.
Head Rail Upgrades <i>(Bottom rail is always fabric wrapped)</i>	
Designer Metallic Upgrade (Smooth Face)	<ul style="list-style-type: none"> • Oil Rubbed Bronze • Onyx Black • Brushed Nickel
Mounting Dimensions	
Finished Dimensions	
Mounting and Finished Dimensions are the same as Cord Loop See Page 128	

COLORLUX® SHANGRI-LA SHEER SHADINGS

Retractable Cord Shadings

The Retractable Cord option is a single cord design that provides easy one hand operation to raise, lower and open and close the vanes.

- Retractable Cord hardware is an alternative to conventional cord loop controls. The short retractable cord maintains a consistent length whether the shadings are raised or lowered. The elimination of cord loop enhances child and pet safety.
- Available with all fabrics with Designer Cassette.
- White, black or bronze cord and tassel coordinates your hardware color choice.
- Standard cord length is 40% the length of the shading. Cord may be shortened to match consumer operating preferences and to keep out of reach of children. Cord length can be easily modified in the field.
- Mounting a cord tensioner is not necessary. Cord cleat is recommended.

Overall Operation

When raising and lowering the shading, pull the cord down in long, even strokes. Allow the cord to fully retract into the head rail after each downward stroke.

To Lower The Shading And Open The Vanes

- Pull the cord down toward the center of the shading with long strokes. Continue until the shading is fully lowered and the vanes are open.
- Allow the cord to retract completely into the head rail after each downward stroke.
- The shading can be stopped at any point while lowering

To Tilt The Vanes And Raise Shading

- Pull the cord straight down or down and slightly out with long strokes. With each stroke the shading partially raises.
- Allow the cord to retract completely into the head rail after each downward stroke.
- Use multiple strokes until the shading reaches the desired position.
- The shading can be stopped at any point while raising.

Color Lux® Shangri-La Sheer Horizontal Shadings

TWO-ON-ONE HARDWARE SYSTEM | DESIGNER CASSETTE HEAD RAIL



Fabric Wrapped

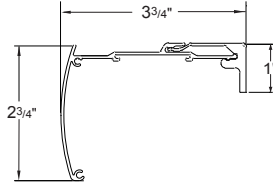

Fabric Wrapped Designer Cassette Head Rail

- Depth of rail and bracket: 3 3/4"
- Height of rail: 2 3/4"
- Height of bracket: 1"

Hardware Features

Standard Designer Cassette	Fabric Wrapped Designer Cassette is standard. Head rail endcap is fabric covered
Bottom Rail Color	Bottom rail is fabric wrapped with white end caps.

Head Rail Upgrades *(Bottom rail is always fabric wrapped)*

Designer Metallic Upgrade (Smooth Face)	<ul style="list-style-type: none"> • Oil Rubbed Bronze • Onyx Black • Brushed Nickel
---	---

Mounting Dimensions

Finished Dimensions

Mounting and Finished Dimensions are the same as Cord Loop
See Page 128

Two-On-One Designer Cassette Head Rail

Two-On-One Head Rail shadings are two shadings sharing the same head rail; each shading operates independently.

- Two-On-One Head Rail can be combined with cord loop, PowerTouch Rechargeable, Simplicity Motorization and retractable cord hardware options. Price as two shadings (including upgrades) and add together. Pricing example on page 125.
- Two-On-One not available with cordless.
- Specify shading total width and two individual section widths. **Note:** The two individual sections must add up to the total width.
- Two on One Head Rail Shadings are available with all vane sizes.
- Two on One Head Rail Shadings are available with bead cord or braided cord loop. See page 129 for more information.
- Controls will always be placed to the far left and far right.
- Available in widths up to 140" with Designer Cassette hardware.
- Minimum single section width is 12". Maximum single section width is 102". The center gap between shadings is 3/8".
- Side by side alignment is available if the two panels measure less than 120". Alignment must be specified when the order is placed.
- Shadings over 98" are subject to common carrier surcharge. See page 152 for more information on the freight policy.

COLORLUX® SHANGRI-LA SHEER SHADINGS

Color Lux® Shangri-La Sheer Horizontal Shadings

CORDLESS HARDWARE SYSTEM | DESIGNER CASSETTE HEAD RAIL



Fabric Wrapped

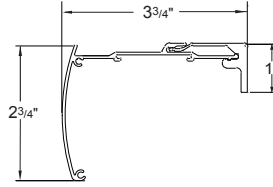

Fabric Wrapped Designer Cassette Head Rail

- Depth of rail and bracket: 3 3/4"
- Height of rail: 2 3/4"
- Height of bracket: 1"

Hardware Features

Standard Designer Cassette	Fabric Wrapped Designer Cassette is standard. Head rail endcap is fabric covered
Bottom Rail Color	Bottom rail is fabric wrapped with white end caps and inner end caps. Handle is clear

Upgrades

Designer Metallic Upgrade (Smooth Face)	<ul style="list-style-type: none"> • Oil Rubbed Bronze • Onyx Black • Brushed Nickel
---	---

Mounting Dimensions	Designer Cassette Head Rail
Minimum Shallow Mount	1"
Minimum Flush Inside Mount (including brackets)	3 3/4"
Minimum Outside Mount	1"
Minimum Side Mount	1 1/4"
Maximum Side Mount	48"

Finished Dimensions

Inside Mount	
	<ul style="list-style-type: none"> • Fabric will measure ordered width less: 7/8" • Head rail* will measure ordered width less: 3/16"
Side (End) Mount	
	<ul style="list-style-type: none"> • Fabric will measure ordered width less: 1 3/8" • Head rail* will measure ordered width less: 1 1/16"
Outside Mount	
	<ul style="list-style-type: none"> • Fabric will measure ordered width less: 1/2" • Head rail* will measure ordered width plus: 3/16"
Exact (End Cap to End Cap) Mount	
	<ul style="list-style-type: none"> • Fabric will measure ordered width less: 1 1/16" • Head rail* will measure ordered width

* Head rail measurements include endcaps. Width and length measurements may vary +/- 1/8"

Please Note: Once ordered and manufactured, the width of the Shangri-La fabric cannot be altered. Comfortex makes deductions to the width depending on the type of mounting indicated. For all mounting types, fabric will measure exactly the length ordered when the vanes are in the closed position.

Color Lux® Shangri-La Sheer Horizontal Shadings

CORDLESS HARDWARE SYSTEM | DESIGNER CASSETTE HEAD RAIL

Cordless Shangri-La Shadings Head Rail

- The Standard Designer Cassette head rail is fabric wrapped.
- Designer Cassette head rail is also available in Oil Rubbed Bronze, Brushed Nickel and Onyx Black.
- Shangri-La Cordless Sheer Horizontal Shadings use quick-snap, no-light-gap brackets.

Cordless Shangri-La Shadings Bottom Rail

- Bottom rail includes a sliding weight to adjust fabric skewing if necessary.
- Bottom rail is always fabric wrapped.

Operating A Cordless Shangri-La Shading

Cordless Shangri-La Shadings utilize a roller catch mechanism in the head rail which allows for the vanes to be adjusted into various positions.

Pull the handle that is attached to the bottom rail until the shading reaches the desired length, allow catch mechanism to engage and lock shade in desired position.

To Open Or Close Vanes

Lower the shading all the way down and continue pulling down on the handle until the vanes open. The roller catch mechanism allows the vanes to be adjusted open, closed and to various positions in between.

When adjusting the vane position, release the catch by tugging on the handle, roll up the shading several inches (this resets the catch mechanism), then pull back down to the desired position.

- The Omni-View setting is not available with Shangri-La Cordless Shadings.

To Raise The Shading

Pull down on the handle to release the catch mechanism and let the shading rise. Tug the handle to lock the shade in the desired position.

When first learning to operate the shading, it may take a few tries to get the feel of the mechanism.



Cordless Handle



Cordless Handle Being Pulled Down



Cordless Handle on Window Sill

Color Lux® Shangri-La Sheer Horizontal Shadings

SHANGRI-LA DOORSTYLES HARDWARE SYSTEM

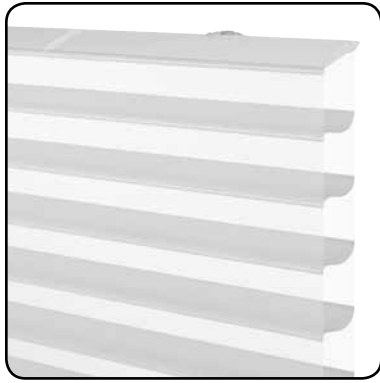

White-on-White Color Lux Prints Only

Hardware Features	
Standard Hardware	Hardware used on DoorStyles Shadings may not match standard shadings.
Bottom Rail Color	Rails and end caps on Shangri-la DoorStyles Shadings are coordinated to the fabric color. With Brushed Nickel Head rail, bottom rail will be coordinated to fabric.
Upgrades	
Designer Metallic Upgrade	DoorStyles
Hinges & Handle	Not Available
	Polished Brass
Mounting Dimensions	
	DoorStyles Hardware
Minimum Shallow Mount	1 1/2"
Minimum Flush Inside Mount (including brackets)	2 5/8"
Minimum Outside Mount	3/4"
Finished Dimensions	
Inside Mount	
	<ul style="list-style-type: none"> • Fabric will measure ordered width less: 5/16" • Head rail* will measure ordered width less: 3/16"
Outside Mount	
	<ul style="list-style-type: none"> • Fabric will measure ordered width • Head rail* will measure ordered width plus: 3/16"
Exact (End Cap to End Cap) Mount	
	<ul style="list-style-type: none"> • Fabric will measure ordered width less: 3/16" • Head rail* will measure ordered width
* Head rail measurements include endcaps. Width and length measurements may vary +/- 1/8" Side Mount is not available for DoorStyles	

Please Note: Once ordered and manufactured, the width of the Shangri-La fabric cannot be altered. Comfortex makes deductions to the width depending on the type of mounting indicated.

Color Lux® Shangri-La Sheer Horizontal Shadings

SHANGRI-LA DOORSTYLES HARDWARE SYSTEM

Shangri-La DoorStyles Shadings

Shangri-La DoorStyles Shadings cover French doors, transoms and sidelights for a look of sheer perfection without a bulky head rail. They attach to the window frame or door with unobtrusive hinges and tilt open and closed with easy to install hardware. An operating handle allows the fabric to be tilted open and closed (Figure A).

Hardware used on DoorStyle Shadings may not match standard shadings.

Fabric

All 3" light filtering and room darkening fabric collections are available as DoorStyle Window Shadings.

Rails and end caps on Shangri-La DoorStyles Shadings are coordinated to the fabric color.

Designer Metallic Hardware Upgrade: Not available with DoorStyles.

Operating Pole

An operating pole is available for hard to reach windows and doors. Please specify when ordering.

6 Foot Expandable Pole

12 Foot Expandable Pole

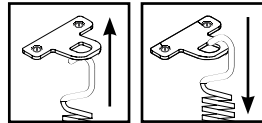

DoorStyles Shading Specifications

Minimum Width: 6" Maximum Width: 72"

Minimum Length: 12" Maximum Length: 72"*

*Maximum length varies by width.

DoorStyles are **not** available with 2½" vane fabrics.

Please Note: Once ordered and manufactured, the width of the Shangri-La fabric cannot be altered. Comfortex makes deductions to the width depending on the type of mounting indicated. For all mounting types, fabric will measure exactly the length ordered when the vanes are in the open or "view-through" position.

Length Considerations With Shangri-La DoorStyles

Comfortex will fabricate your Shangri-La DoorStyles to the length ordered when the vanes are in the open (or view through) position. When the vanes are tilted to the closed position, the shading will become 1¾" longer.

When closed on an inside mount or when used with hold down brackets, a slight puckering may occur.

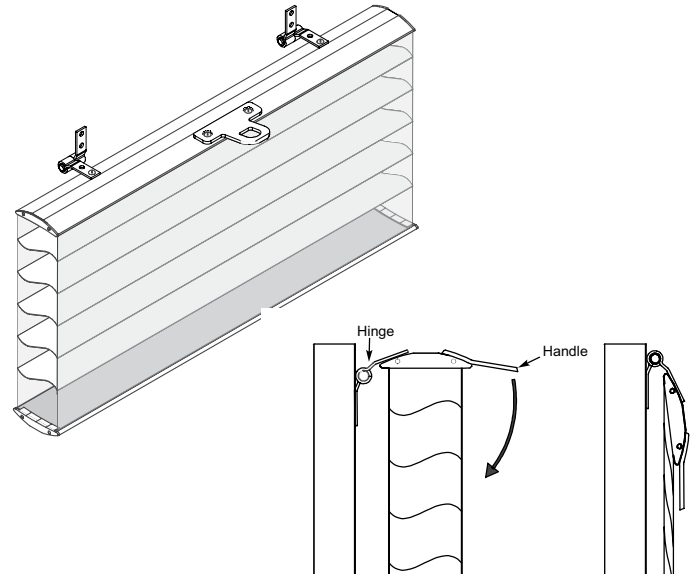
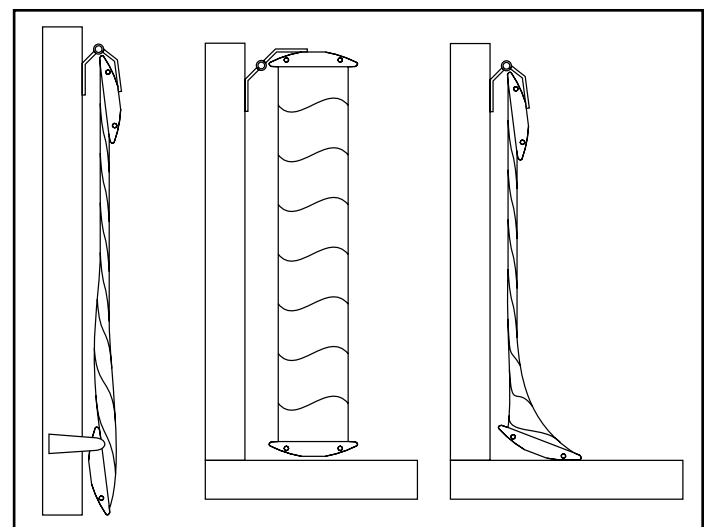

Figure A



Color Lux® Shangri-La Sheer Horizontal Shadings

7.4V RECHARGEABLE POWERTOUCH HARDWARE SYSTEM | DESIGNER CASSETTE HEAD RAIL



Fabric Wrapped

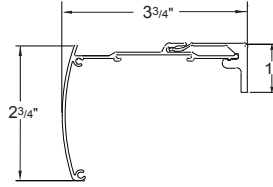

Fabric Wrapped Designer Cassette Head Rail

- Depth of rail and bracket: 3 3/4"
- Height of rail: 2 3/4"
- Height of bracket: 1"

Hardware Features	
Standard Designer Cassette	Fabric Wrapped Designer Cassette is standard. Head rail endcap is fabric covered
Bottom Rail Color	Bottom rail is fabric wrapped with white end caps.
Head Rail Upgrades <i>(Bottom rail is always fabric wrapped)</i>	
Designer Metallic Upgrade (Smooth Face)	<ul style="list-style-type: none"> • Oil Rubbed Bronze • Onyx Black • Brushed Nickel
Mounting Dimensions	
Designer Cassette Head Rail	
Minimum Shallow Mount	1"
Minimum Flush Inside Mount (including brackets)	3 3/4"
Minimum Outside Mount	1"
Minimum Side Mount	1 1/4"
Width Side Mount	48" Max width side mount
Finished Dimensions	
Inside Mount	
	<ul style="list-style-type: none"> • Fabric will measure ordered width less: 1" • Head rail* will measure ordered width less: 3/16"
Side (End) Mount	
	<ul style="list-style-type: none"> • Fabric will measure ordered width less: 1 1/2" • Head rail* will measure ordered width less: 1 1/16"
Outside Mount	
	<ul style="list-style-type: none"> • Fabric will measure ordered width less: 5/8" • Head rail* will measure ordered width plus: 3/16"
Exact (End Cap to End Cap) Mount	
	<ul style="list-style-type: none"> • Fabric will measure ordered width less: 1 3/16" • Head rail* will measure ordered width
* Head rail measurements include endcaps. Width and length measurements may vary +/- 1/8"	

Please Note: Once ordered and manufactured, the width of the Shangri-La fabric cannot be altered. Comfortex makes deductions to the width depending on the type of mounting indicated. For all mounting types, fabric will measure exactly the length ordered when the vanes are in the open position.

Color Lux® Shangri-La Sheer Horizontal Shadings

7.4V RECHARGEABLE POWERTOCH HARDWARE SYSTEM | DESIGNER CASSETTE HEAD RAIL

PowerTouch™ Rechargeable Shades

Sheer Shadings can be fabricated with the PowerTouch Rechargeable Push Button Control option. The PowerTouch Rechargeable option is an easy, cord free motorized operation for the budget savvy homeowner. PowerTouch Rechargeable uses Simplicity motors and components.

PowerTouch Rechargeable Shades Operation

Press the up or down button on the pendant to raise or lower the shading to your desired position. When the shading is fully lowered to the factory programmed lower limit, the bottom rail will be set in the level position.

No programming is required with PowerTouch™, all programming is set at the factory. Upper and lower limits easily can be adjusted in the field if desired. Please refer to the installation instructions at comfortex.com/comfortex-dealers. Favorites position can be programmed on-site.

PowerTouch Rechargeable Surcharges

See page 125.

PowerTouch Appearance

- The PowerTouch Rechargeable wand and pendant is attached to the head rail and requires no additional mounting.
- The wand and pendant hangs down the front of the shades from the head rail. The wand does not touch the fabric.
- Pendant is 2½" long.
- The pendant does not need to be mounted to the wall to operate the shade.



PowerTouch Rechargeable Color Options

- Shadings with Black or Oil Rubbed Bronze hardware will be built with black wand and pendants standard. All other colors will use white wand and pendants.



White



Black Shown with Plug-In Charger

PowerTouch Rechargeable Wand Length

The standard length of the wand will measure the indicated below unless otherwise specified.

Shading Length	Standard Wand Length
Up to 30"	1' (12")
>30" to 52"	2' (24")
>52" to 78"	3' (36")
>78" to 100"	4' (48")
>100" to 120"	5' (60")

- Wand length is in 1 foot increments. 1 foot - 5 foot

Mounting Requirements for PowerTouch Rechargeable Shadings

- No special installation hardware or wiring requirements are needed.
- The wand and pendant do not need to be mounted to operate the shading.

Integrated Rechargeable Motor Battery Life

Rechargeable battery is included with the motor.

The average battery charge will last 6-12 months based on an average sized shade raised and lowered once per day. The life of the battery charge will vary based on the type of window covering selected, the size and weight of the window covering and the number of times the shade is operated on a daily basis.

The battery can be recharged up to 500 times. It takes approximately 5 hours to recharge the motor when fully depleted.

Battery Charger

8.4 Volt charger requires a standard power outlet to recharge the battery. Must specify charger when ordering a Simplicity PowerTouch Rechargeable Shading. The charger plugs into the charger port. The charger is black and comes with a 156" wire. The dimensions are 1" wide x 2½" length x 1¾" deep.



PowerTouch Rechargeable Shadings Warranty

Please see page 154 for complete warranty information.

PowerTouch Wand and Pendant Location

The standard location for the wand and pendant is on the right. Please specify location when ordering.

Color Lux® Shangri-La Sheer Horizontal Shadings

12V NON-RECHARGEABLE SIMPLICITY MOTORIZATION | DESIGNER CASSETTE HEAD RAIL



Fabric Wrapped

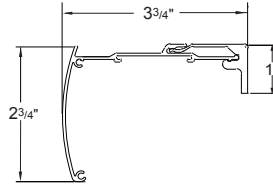

Smooth Face Designer Cassette Head Rail

- Depth of rail and bracket: 3 3/4"
- Height of rail: 2 3/4"
- Height of bracket: 1"

Hardware Features	
Standard Designer Cassette	Fabric Wrapped Designer Cassette is standard. Head rail endcap is fabric covered
Bottom Rail Color	Bottom rail is fabric wrapped with white end caps.
Head Rail Upgrades <i>(Bottom rail is always fabric wrapped)</i>	
Designer Metallic Upgrade (Smooth Face)	<ul style="list-style-type: none"> • Oil Rubbed Bronze • Onyx Black • Brushed Nickel
Mounting Dimensions	
Designer Cassette Head Rail	
Minimum Shallow Mount	1"
Minimum Flush Inside Mount (including brackets)	3 3/4"
Minimum Outside Mount	1"
Minimum Side Mount	1 1/4"
Width Side Mount	48" Max width side mount
Finished Dimensions	
Inside Mount	
	<ul style="list-style-type: none"> • Fabric will measure ordered width less: 1" • Head rail* will measure ordered width less: 3/16"
Side (End) Mount	
	<ul style="list-style-type: none"> • Fabric will measure ordered width less: 1 1/2" • Head rail* will measure ordered width less: 1 1/16"
Outside Mount	
	<ul style="list-style-type: none"> • Fabric will measure ordered width less: 5/8" • Head rail* will measure ordered width plus: 3/16"
Exact (End Cap to End Cap) Mount	
	<ul style="list-style-type: none"> • Fabric will measure ordered width less: 1 3/16" • Head rail* will measure ordered width
* Head rail measurements include endcaps. Width and length measurements may vary +/- 1/8"	

Please Note: Once ordered and manufactured, the width of the Shangri-La fabric cannot be altered. Comfortex makes deductions to the width depending on the type of mounting indicated. For all mounting types, fabric will measure exactly the length ordered when the vanes are in the open position.

Color Lux® Shangri-La Sheer Horizontal Shadings

12V NON-RECHARGEABLE SIMPLICITY MOTORIZATION | DESIGNER CASSETTE HEAD RAIL

Simplicity Motors

The Simplicity Motor program features a battery powered motor utilizing a single battery wand or plug-in DC transformer. Simplicity motors are compact and use a radio frequency remote to raise or lower the shadings. The Simplicity motor is concealed in the head rail.

See page 140 for information on Simplicity Rechargeable system version.

Simplicity Motors With Designer Cassette

No special installation hardware or wiring requirements are needed to install motorized Shangri-La Shadings with Designer Cassette Head Rail. See page 22 for mounting information.

Simplicity Battery Wand

The battery wand can be clipped to the Designer Cassette head rail. Can not be mounted on shadings under 25" wide. The battery wand is wall or ceiling mounted utilizing white battery wand clips. The 12 volt battery wand measures 17¼", and comes with eight alkaline batteries, and is white in color. The battery wand must be placed so it does not interfere with the mounting brackets.

The battery wire is 10" long. A 48" extension wire is available.



Simplicity Motor Battery Life and Replacement

Eight alkaline batteries are included with the wand. The battery life will vary based on the type of window covering selected, the size and weight of the window covering and the number of times you operate the shade on a daily basis.

Comfortex will warranty batteries for up to 3 months from date of purchase. Batteries are not covered by the warranty.

DC Power Supply/Transformer

12 Volt DC power supply/transformer is available and requires a standard power outlet to power the motor. The transformer is an alternative to a battery wand. Each transformer can power a single shading. The power supply must plug in to the motor. The DC power supply is white and comes with a 80" wire. The dimensions are 1⅞" wide x 3¼" long x 1¼" deep. Extension wires are available if needed.



Important Simplicity Motorized Shading Operating and Installation Information

Simplicity Motorized Shadings installed into windows with metal casings may have a reduced radio frequency range, or may not operate at all, depending on the application

Simplicity Motor Hand Held Remotes

IMPORTANT: Simplicity Rechargeable Motorized Shadings are programmed at the factory with the "up and down" limits. The shades are **UNLINKED** from the remote so they are not able to operate during shipping. Each shade should be installed **before** linking it to the remote.

5 Channel Remote

The **5 Channel (5C) remote** can operate up to five shadings simultaneously, individually or in groups.

Simplicity (5C) remotes and holders are black or white in color. The remote comes with a holder which can be mounted to a wall for easy storage. The range of the remote is approximately 80 feet.



6 Channel Timer Remote

The **6 Channel (6C) timer remote** combines the functionality of a six channel hand-held control with the convenience of a programmable timer.

- The 6C timer remote allows for 18 different scheduled actions.
- Manual function disables the timer and the remote then operates as a hand held remote.

Simplicity (6C) remotes and holders are available in white. The remote comes with a holder which can be mounted to a wall for easy storage. The range of the remote is approximately 80 feet.



14 Channel White Remote also available

Please Note:

- Not all motors run at the same rate of speed.
- Simplicity motors have a "Favorites" or "MY" position setting. If the homeowner wants to set several shadings at the same intermediate position, follow instructions provided with installation manual.

Simplicity Battery Operated Motorized Shadings Warranty

Please see page 154 for complete Comfortex warranty information.

COLORLUX® SHANGRI-LA SHEER SHADINGS

Color Lux® Shangri-La Sheer Horizontal Shadings

7.4V RECHARGEABLE SIMPLICITY HARDWARE SYSTEM



**Fabric
Wrapped**

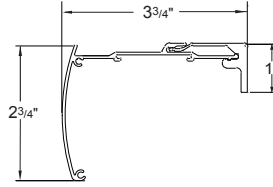

Fabric Wrapped Designer Cassette Head Rail

- Depth of rail and bracket: 3 3/4"
- Height of rail: 2 3/4"
- Height of bracket: 1"

Hardware Features	
Standard Designer Cassette	Fabric Wrapped Designer Cassette is standard. Head rail endcap is fabric covered
Bottom Rail Color	Bottom rail is fabric wrapped with white end caps.
Head Rail Upgrades <i>(Bottom rail is always fabric wrapped)</i>	
Designer Metallic Upgrade (Smooth Face)	<ul style="list-style-type: none"> • Oil Rubbed Bronze • Onyx Black • Brushed Nickel
Mounting Dimensions	
Designer Cassette Head Rail	
Minimum Shallow Mount	1"
Minimum Flush Inside Mount (including brackets)	3 3/4"
Minimum Outside Mount	1"
Minimum Side Mount	1 1/4"
Width Side Mount	48" Max width side mount
Finished Dimensions	
Inside Mount	
	<ul style="list-style-type: none"> • Fabric will measure ordered width less: 1" • Head rail* will measure ordered width less: 3/16"
Side (End) Mount	
	<ul style="list-style-type: none"> • Fabric will measure ordered width less: 1 1/2" • Head rail* will measure ordered width less: 1 1/16"
Outside Mount	
	<ul style="list-style-type: none"> • Fabric will measure ordered width less: 5/8" • Head rail* will measure ordered width plus: 3/16"
Exact (End Cap to End Cap) Mount	
	<ul style="list-style-type: none"> • Fabric will measure ordered width less: 1 3/16" • Head rail* will measure ordered width
* Head rail measurements include endcaps. Width and length measurements may vary +/- 1/8"	

Please Note: Once ordered and manufactured, the width of the Shangri-La fabric cannot be altered. Comfortex makes deductions to the width depending on the type of mounting indicated. For all mounting types, fabric will measure exactly the length ordered when the vanes are in the open position.

Color Lux® Shangri-La Sheer Horizontal Shadings

7.4V RECHARGEABLE SIMPLICITY HARDWARE SYSTEM

Simplicity Rechargeable Motors

The Rechargeable Simplicity Motor program features an integrated rechargeable lithium ion battery in the motor casing and is fully concealed by the roller tube.

PowerTouch Integrated Rechargeable Surcharges

See page 122 for shading standards and page 125 for surcharges and pricing example.

Simplicity Rechargeable Motors

No special installation hardware or wiring requirements are needed to install motorized Shangri-La Shadings with Designer Cassette Head Rail. No external battery wand is required. See page 140 for mounting information.

Rechargeable Simplicity Motor Batteries

The battery for the integrated rechargeable simplicity motor system is integrated within the motor casing and is fully concealed by the roller tube.

Rechargeable battery comes fully charged from the factory.

Integrated Rechargeable Motor Battery Life

Rechargeable battery is included with the motor.

The average battery charge will last 6-12 months based on an average sized shade raised and lowered once per day. The life of the battery charge will vary based on the type of window covering selected, the size and weight of the window covering and the number of times the shade is operated on a daily basis.

The battery can be recharged up to 500 times. It takes approximately 5 hours to recharge the motor when fully depleted.

Integrated Rechargeable Motor Battery Charger

An 8.4 Volt charger requires a standard power outlet to recharge the battery. The charger must be specified when ordering an Integrated Rechargeable Simplicity Motorized shade. The charger plugs into the charging port of the motor. Required with Integrated Shading order. Sold separately.



The charger is black and comes with a 156" wire. The dimensions are 1" wide x 2½" length x 1¾" deep.

Simplicity Motor Hand Held Remotes

IMPORTANT: Simplicity Rechargeable Motorized Shadings are programmed at the factory with the "up and down" limits. The shades are **UNLINKED** from the remote so they are not able to operate during shipping. Each shade should be installed **before** linking it to the remote.

5 Channel Remote

The **5 Channel (5C) remote** can operate up to five shadings simultaneously, individually or in groups.

Simplicity (5C) remotes and holders are black or white in color. The remote comes with a holder which can be mounted to a wall for easy storage. The range of the remote is approximately 80 feet.



6 Channel Timer Remote

The **6 Channel (6C) timer remote** combines the functionality of a six channel hand-held control with the convenience of a programmable timer.

- The 6C timer remote allows for 18 different scheduled actions.
- Manual function disables the timer and the remote then operates as a hand held remote.

Simplicity (6C) remotes and holders are available in white. The remote comes with a holder which can be mounted to a wall for easy storage. The range of the remote is approximately 80 feet.



A **14 Channel (14C) remote** is also available. This remote is required for TDBU motorization but can be utilized on all Simplicity motorized shades. See page 32 for more information.

Please Note:

- Not all motors run at the same rate of speed.
- Simplicity motors have a "Favorites" or "MY" position setting. If the homeowner wants to set several shadings at the same intermediate position, follow instructions provided with installation manual.
- **WHEN ORDERING THE NEW INTEGRATED RECHARGEABLE, PLEASE ORDER THE NECESSARY BATTERY CHARGER.**

Solar Panel Recharge Option

Plugs in to any Simplicity Rechargeable Remote control shade (does not work with PowerTouch). See page 142.

Color Lux® Shangri-La Sheer Horizontal Shadings

7.4V RECHARGEABLE SIMPLICITY HARDWARE SYSTEM

Important Information about Integrated Rechargeable Simplicity Motor Shading Operation and Installation

- Simplicity Motorized Shadings installed into windows with metal casings may have a reduced radio frequency range, or may not operate at all, depending on control.
- Be mindful of when your shade starts to slow down during operation. It is a good indicator the shade needs to be recharged.

Simplicity Battery Operated Motorized Shadings Warranty

Please see page 154 for complete Comfortex warranty information.

Solar Panel Recharge Option

Plugs in to any Simplicity Rechargeable Remote control shade (does not work with PowerTouch)

Provides constant trickle charge to 7.4v Li-Ion Rechargeable battery packs. Does not require direct sunlight, but performs best in regular direct sunlight applications. Will prolong the life of the charge of the 7.4v rechargeable battery packs, and in some applications will maintain charge indefinitely.

Life of charge is subject to application variables such as, size and weight of shade, frequency of use, amount of direct sunlight exposure, etc.



Dimensions of panel
18½" x 1½"



Color Lux® Shangri-La Sheer Horizontal Shadings

7.4V RECHARGEABLE SIMPLICITY HARDWARE SYSTEM

EZ Charge Extension Wand Option

EZ Charge Extension Wand is the newest innovation in rechargeable motorization. Easily charge your hard to reach Simplicity Rechargeable Shades with the EZ Charge Extension Wand. The wand extends up to 31" in length.

Simple to use! Place the magnetized wand tip on the receiving port to attach. Then plug the charger into the base of the wand. It is that simple!

- EZ Charge Extension Wand can be easily concealed by a valance or drapery panel.
- Great for out of reach windows

EZ Charge Wall Mount Receiver

- The EZ Charge Wall Mount Receiver includes screws and anchors. These can be used for wood or drywall mounting.
- Extension cable plugs into charging port of Simplicity Rechargeable shades.



EZ Charge Wall Mount Receiver Kit | CKIT078
One kit per Simplicity Motorized shade is needed.

EZ Charge Wand

- Wand is 9½" and extends to 31"
Magnetized tip makes connection quick and easy.
- Once wand is in place plug the 8.4v charger into the bottom of the extension wand for charging.

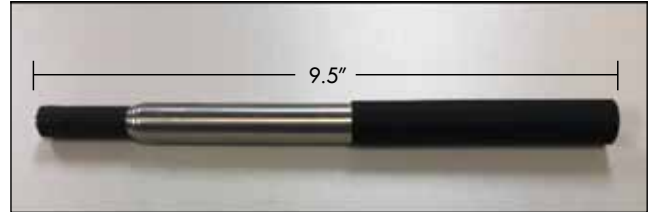

EZ Charge Wand | CKIT077
Order with the EZ Charge Wall Mount Receiver Kit



EZ Charge Receiving Port



Port/Wand Connection

Shade/Blind Product	EZ Charge Wall Mount Receiver List Price	EZ Charge Wand List Price
Sheer	\$31	\$56



Battery Charger



Wand Base

Battery Charger - SOLD SEPARATELY

You must specify charger when ordering a Simplicity Rechargeable Motorized Shade. The charger plugs into the wand base. The 8.4 Volt charger requires a standard power outlet to recharge the motor. The charger is black and comes with a 156" wire. The dimensions are 1" wide x 2½" length x 1¾" deep.

Cellular Shade Collection

12V SIMPLICITY LOW VOLTAGE HARDWIRING SYSTEM

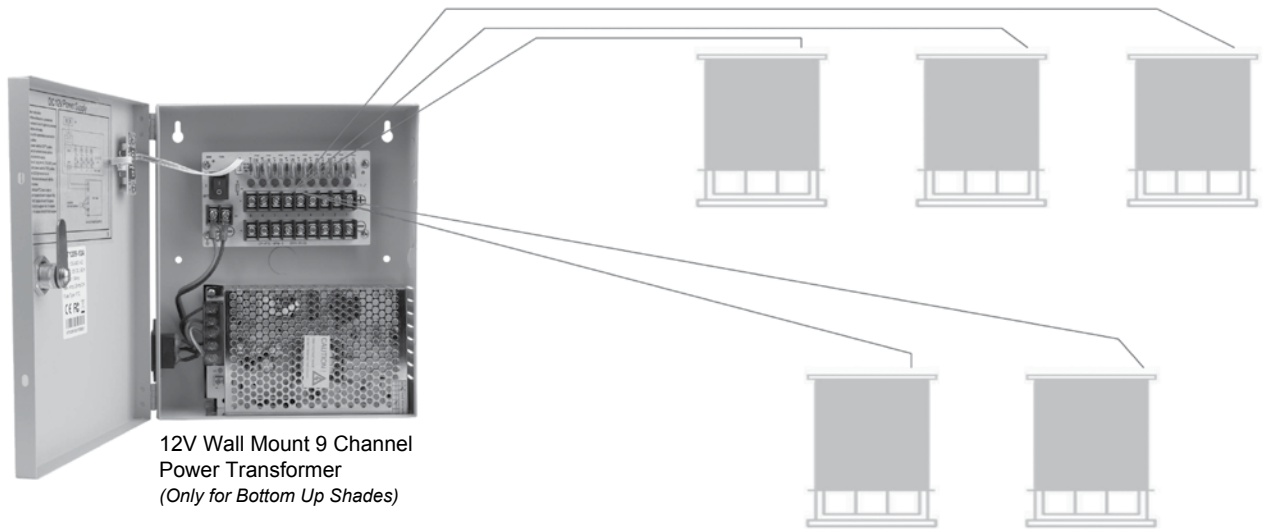

12V Low Voltage Hard Wired

Low Voltage hardwire powered motors are available for Roller Shades, Sheer Shadings and Cellular bottom up shades. The system offers a maintenance-free power option for Simplicity Motorized Shades. Our Simplicity power transformer mounts in a safe dry location (such as your basement), out of sight, and provides power for up to nine individual shades per box.

2 Conductor wires should be pre-installed by a licensed contractor according to local building codes, to connect power from the transformer to the shades.

Simply use the wire adapters provided to connect the power wire to the Simplicity motor power input on the back of the shade, then connect the pre-run wires to the (+ / -) terminal block in the transformer box, and flip on the power switch.

- Product Dimension: 7.875" wide, 9.4" Tall, 2.45" deep
- Converts incoming 120V AC to outgoing 12V for up to 9 shades.

• **Product Description:**

- 12v10a 9ch
- Input Voltage Range : AC90V-264V
- Input Frequency Range : 50Hz-60Hz
- Output Voltage Range : DC12V+/-5%
- Output Current : 10 Ampere
- Output Power : 120 Watt
- Output Ripple&Noise : ≤42MV
- Output Efficiency : ≥83%
- Output Fuse Type : PTC
- Output Fuse Rating : 2A
- Environment Operating Amb.Temp : -30 ~45
20%~90%RH
- Environment Storage Temp : -40 ~85 10%~95%RH
- Plugs into standard household outlet
- Power cord is 56" in length



2 Conductor Wires running to basement 12V Power Transformer

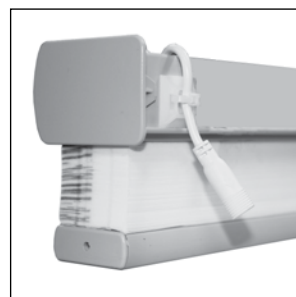

Power port on back of shade



Wires connecting to charging port on Simplicity shade



12V Wall Mount 9 Channel Power Transformer

Color Lux® Shangri-La Sheer Horizontal Shadings

SIMPLICITY SMART CONTROLLER



Simplicity Smart Controller Dimensions

- Width of controller: 2³/₈"
- Length of controller: 2¹⁵/₁₆"
- Height of controller: 1¹/₈"

Simplicity Smart Controller

- Works with Apple and Android devices
- FREE Downloadable Application
- Compatible with previously installed Simplicity Remote Controlled Shades
- Powered by NEO Smart Blinds App.
- Compatible with Amazon Alexa, Google Assistant systems, Control4 and Savant systems

COLORLUX® SHANGRI-LA SHEER SHADINGS

Simplicity Smart Controller

The Simplicity Smart Controller is a small device that you install in your home that allows you to set automatic opening and closing times for all Simplicity motorized shades as well as the ability to control your motorized shades from a phone, tablet or PC anywhere in world.

The Simplicity Smart Controller will work with any Comfortex motorized shade with Simplicity Remote Controlled motors purchased after 2012.

The Simplicity Smart Controller plugs into a standard electrical outlet and connects to WiFi and sends signals to your shades using the same radio frequencies as a normal remote control.

How Does The NEO Smart Blinds App Work?

The app uses WiFi or cellular data to send commands over the internet to the Simplicity Smart Controller.

Do I Need Any Other Equipment?

Yes, The location where your shades are installed must have WiFi in order for the Simplicity Smart Controller to work. Additionally, you must have a smartphone or tablet running Android or iOS (eg. iPhone, iPad, Samsung Galaxy S7) and have the NEO Smart Blinds app. installed.

Why Would I Want A Simplicity Smart Controller?

There are 2 main ways the Simplicity Smart Controller adds additional value to your motorized shades. First, once all of your shades have been added you can use your smartphone as a single remote for all of your shades. It will work anywhere you are regardless of distance from the shade. Secondly, the device allows you to set schedules so your motorized shades automatically open and close without needing to do anything on a day to day basis.

Do I Need To Buy More Than 1 Controller?

The normal use for the Simplicity Smart Controller is to plug it in out of the way and forget it. Since it has roughly the same range as a remote you will want enough devices to allow all shades to be operated without moving the controller. So depending on the layout of the home and location of the shade, you might want multiple devices to have convenient full home coverage.

How Far Is The Range Of A Controller?

You should see a range of approximately 150 ft. However this number might be less depending on the layout of your home. In general we recommend one per a floor of a normal sized home.

Can I Control My Shades From Multiple Devices?

Yes! You can download the NEO Smart Blinds app onto multiple devices, After installing the app on a new device simply log in with the same email/password on each device and you will have access to control your shades.

Can It Be Used With Already Installed Shades?

Yes! Simply follow the directions in the NEO Smart Blinds app to add a shade. At the pairing step you can put the shade in pairing mode using the primary remote control for it (or by accessing the button on the shades motor). Adding the shade to the NEO Smart Blinds app will not affect the normal remote operation.

How Much Does The NEO Smart Blinds App Cost?

The app is a free download, However you must have at least one Simplicity Smart Controller to serve as a bridge between the app and your Shades. See page 125.

Color Lux® Shangri-La Sheer Horizontal Shadings

GENERAL INFORMATION

Certified Fabrics | GREENGUARD® Fabrics

GREENGUARD Environmental Institute has established performance based standards to define goods with low chemical and particle emissions for use indoors.

The Shangri-La fabrics have the passed GREENGUARD Indoor Air Quality Certified® certification program for low emitting interior building materials, furnishings, and finish systems.

Flame Resistance

Shangri-La fabric may be processed with a topical treatment to resist flames and adhere to strict flammability codes. For more information, contact Customer Service at (800) 843-4151.

UV Protection

Ultraviolet light, entering the home as sunlight, damages furnishings. In time it fades wood floors, furniture, upholstery, draperies, carpeting and artwork. Prolonged exposure to sunlight causes natural, undyed fabrics to turn yellow, weakening their fibers and making them look old and worn prematurely.

The right window covering can be very effective in blocking ultraviolet rays. Such effectiveness is measured in terms of a "% UV blockage" rating. The higher the rating, the greater the UV protection.

Shangri-La fabrics have the following UV Protection ratings:

Light Filtering Fabrics	Open Vanes	87%
Room Darkening Fabric	Open Vanes	88%
All Fabrics	Closed Vanes	99%

Vane Closure

Shangri-La vanes are not designed to close tightly. The inherent nature of the fabric will cause a slight increase in the distance from the front sheer to back sheer as you move further down the shading. These vanes do not form a perfect seal against light leakage which is most visible toward the bottom of the shading. Vane overlap ensures that privacy is not compromised.

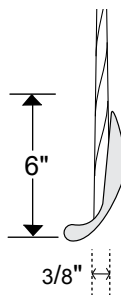

Vane closure is measured as the distance between the front and rear fabric sheers 6" up from the lowest point of the bottom rail, with the shading fully lowered and the vanes closed.

On light filtering fabrics, the maximum distance from the front sheer to the back sheer when closed is equal to or less than 3/8" for shadings under 60" and 5/8" for shadings longer than 60". On room darkening fabrics, the distance is 3/8" regardless of shading length.

Vane Opening and Visibility

Vaness on the three styles of Shangri-La fabrics open to slightly different degrees. Consequently, there are variations in visibility through the shadings when the vanes are tilted to their maximum open positions. The variations among the products are shown in the below illustration when looking through the shading 1/4 of the way up from the bottom.

3" Fabrics

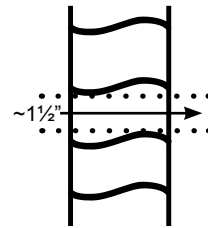

Magnetic Hold-Down Brackets

Optional magnetic hold-down brackets secure the bottom of the shading to prevent swaying. Please specify when ordering.

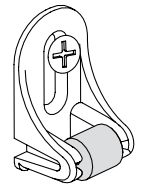

Extension Brackets

Extension or "L" brackets are available to project the back of the shading from the mounting surface. The extension brackets for Designer Cassette head rail projects it 3".

Spacer Blocks

Spacer blocks project the shading 3/8" from the mounting surface. Use spacer blocks to obtain clearance when obstructions, such as window cranks or door handles, obstruct the movement of the shading.

Leveling Shangri-La Sheer Shadings

Shangri-La Window Shadings are leveled and weighted in the factory. When installed level, the fabric will not skew when raised. If the head rail is not installed level, skewing can occur that can damage the edge of the fabric. Be sure to follow the installation instructions carefully to ensure correct and balanced operation.

Child Safety

Please see page 150 for child safety information.

Color Lux® Shangri-La Sheer Horizontal Shadings

GENERAL INFORMATION

Measuring Instructions for Sheer Shadings

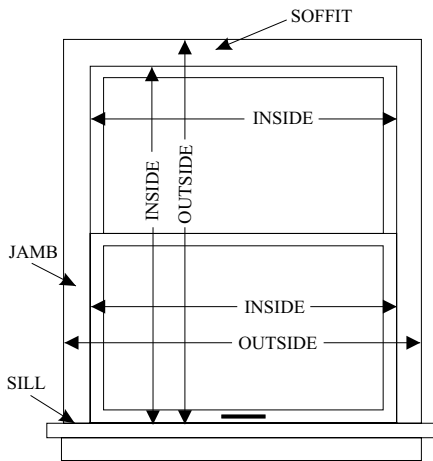

Important Measuring Guidelines for Sheer Shadings. Comfortex accepts measurements down to 1/16" increments.

Precise width and length measurements are critical. Fabric width cannot be altered after the shading is fabricated.

Please use a metal tape measure for accuracy.

The head rail must be installed perfectly level to ensure smooth operation. On an inside mount, it is recommended that you check to see that the mounting surface is level and consistent. If your soffit needs to be leveled, this should be done before measuring.

Inside Mount

Measure across the width of your window opening in three different places - top, middle and bottom. Measurements should be taken within the window jamb. Provide the smallest of the three measurements to Comfortex. Be exact. Comfortex will make the necessary deductions to fit the window opening.

Measure the length of the window opening from the underside of the soffit to the surface of the window sill in two places - use the smallest of these two measurements.

Outside Mount

Measure the exact width and length of the area to be covered. On the width, allow at least 1 1/2" of an overlap on each side. An overlap of 3" on each side is recommended. Be sure to take into consideration any obstructions such as window trim, molding, locks and window cranks.

Side Mount

Side mount is not available with DoorStyles Shadings.

Shangri-La may be side mounted using "L" brackets. For side mounts, follow the instructions for inside mounts. An additional 1/2" will be taken off the standard inside mount deduction to allow room for the "L" brackets.

The maximum shading width utilizing the side mount option is 48".

Skew Adjusting Bottom Rail

After installation, windows that are not square and level may cause the shadings to shift to one side as it rolls up, requiring adjustment of the bottom rail. If the brackets are not level it may be necessary to adjust the bottom rail weight.

- To access the bottom rail weight, release the weight clip on the bottom rail by using a flat blade screwdriver. Insert it into the weight clip in the bottom rail and turn clockwise.
- Move the weight in 1" increments toward the side where the fabric is gathering.
- Secure the weight clips in position by turning them counterclockwise after making the adjustment.

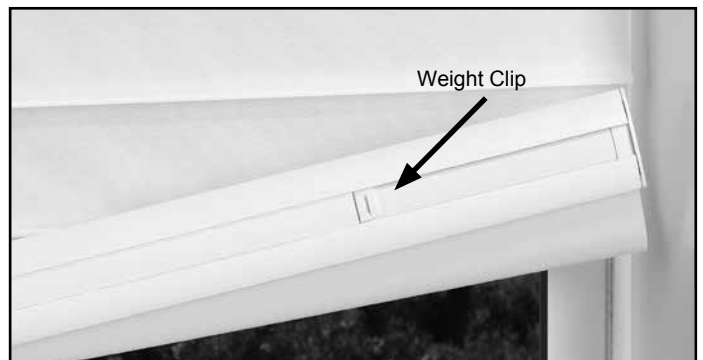

Cleaning and Care

Shangri-La Shadings are made from a sturdy, knitted polyester fabric which can be feather dusted or vacuumed at a low setting. Spots or stains can be lightly rubbed clean with a damp sponge and mild soap. To avoid discoloration of the material, we recommend against the use of chemical cleaners.

Precautions should be taken to reduce exposure to harsh environmental elements, such as salt air. Continuous exposure to salt air through open windows and doors will accelerate fabric deterioration over time.

Important: Do not clean the fabric using electrostatic wipes such as Swiffer® or Pledge Grab-It®.

Ultrasonic Cleaning

Shangri-La Shadings can be ultrasonically cleaned. Adco OnSite Fabricare provides shading and blind cleaning services. For more information, visit www.onsitefabricare.com. Comfortex acknowledges these cleaning methods as being safe and effective. We cannot attest to the quality of equipment or services provided by any independent cleaning facility.

For additional advice on care or cleaning, please contact the Comfortex Technical Service Department at 800-843-4151.

COLOR LUX® GENERAL INFORMATION



COLOR LUX[®]
Designer Cellular & Roller Shades

COLORLUX® GENERAL INFORMATION

Color Lux® Shades

GENERAL INFORMATION

Cut-Outs, Scotchgard Protection, Certified Fabrics and Highlights Cornice Valances

Cut-Outs

Cut-outs are available with all cellular fabrics. Cut-outs are \$55.00 per side and are subject to approval by the Comfortex Technical Service department.

There are no limits on cut out lengths. There are limits on cut out widths:

Cellular shade widths 18" or less 3" maximum width

Cellular shade widths greater than 18" 5" maximum width

Scotchgard™ Protection

Scotchgard™ Protector is available with Color Lux Cellular, Roller and Panel Track Shades.

Scotchgard™ keeps your shades looking newer, fresher and cleaner longer.



A combination of the latest advances in stain release and repellency provides exceptional stain protection. Spills wipe away easily and most dirt and stains lift out when cleaned.

Certified Fabrics

GREENGUARD Indoor Air Quality Certified® Fabrics
The GREENGUARD Environmental Institute has established performance based standards to define goods with low chemical and particle emissions for use indoors.

Color Lux Linen Weave fabrics have received GREENGUARD Indoor Air Quality Certified® certification for low emitting interior building materials, furnishings, and finish systems.

Highlights Cornice Valances

Elevate your windows to a whole new level of design with the Highlights Cornice Valance. Coordinate with other design elements in your room and add a finishing touch to the top of any window treatment. The Highlights Cornice Valance is versatile and beautiful at a price point that won't leave you wondering how to cover the rest of your windows!

Choose from any color in the Color Lux Roller line and customize the valance with our 7 available return sizes to best fit your application.

Easy assembly and quick installation, with the Highlights Cornice Valance, more beautiful windows are within your reach.

Shade Stack Heights

Measurements are in inches. Shade stacking heights applicable when the shade is in the fully raised position.

	48"	72"	84"	96"
Standard Rectangular (Includes head and bottom rails)	2	2 $\frac{3}{8}$	2 $\frac{3}{8}$	2 $\frac{7}{8}$
Top Down - Bottom Up (Includes head, middle and bottom rails)	2 $\frac{3}{8}$	3	3 $\frac{1}{4}$	3 $\frac{3}{8}$
Cord Loop (Includes head and bottom rails)	3	3 $\frac{3}{8}$	3 $\frac{3}{8}$	3 $\frac{7}{8}$
Motorization (Includes head and bottom rails)	3	3 $\frac{3}{8}$	3 $\frac{3}{8}$	3 $\frac{7}{8}$

	48"	60"	72"	84"
Cordless Ultra (Includes head and bottom rails)	3	3 $\frac{1}{4}$	3 $\frac{3}{8}$	3 $\frac{3}{8}$
Cordless Ultra Top Down - Bottom Up (Includes head, middle and bottom rails)	3 $\frac{3}{8}$	3 $\frac{3}{8}$	4	4 $\frac{1}{4}$
Cordless Lift & Lock (Includes head and bottom rails)	2 $\frac{3}{4}$	3 $\frac{1}{8}$	3 $\frac{3}{8}$	3 $\frac{3}{8}$
Cordless Lift & Lock Top Down - Bottom Up (Includes head, middle and bottom rails)	3 $\frac{3}{8}$	4 $\frac{1}{4}$	4 $\frac{1}{2}$	4 $\frac{3}{4}$

COLORLUX® GENERAL INFORMATION

 WARNING/ADVERTENCIA	
5.1.3	Rev. 5/18 Print 5/18
	<p>Window Blind Cord Can STRANGLE Your Child. To prevent strangulation, purchase cordless products or products with inaccessible cords.</p> <p>La cuerda de la persiana puede ESTRANGULAR a su niño. Para evitar el estrangulamiento, compre alternativas cuerda o productos con cuerdas inaccesibles.</p>

Child Safety

Comfortex has a long history of designing new child-safety products and is proud to provide a leadership role in cooperating with the Consumer Product Safety Commission (CPSC) for the development of policies and guidelines for the industry by serving on the WCMA Standards Development Committee.

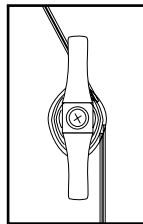

Cord Cleat



Cord Tensioner

All Comfortex products have been fully tested and proven to comply with the current WCMA Standards for safety of corded window coverings.

Be aware that it is possible for children to become entangled in window covering cords. To reduce the risk of accidents, all cords must be kept out of the reach of children.

A cord cleat or cord tensioner is an effective way to implement this essential precaution. Please use them.

To mount the cord cleat at a safe height, take into account furniture or other objects upon which a child may climb. Then, after the use of the blind, simply wrap the excess cord around the cleat.

Cleaning and Care

While beautiful and pleasing to the eye, all Comfortex products are designed to be durable, easily cared for and easily cleaned. Our non-woven fabrics are inherently anti-static and repel dust, but occasional feather dusting or vacuuming may be necessary to keep the fabrics clean and bright. Comfortex Color Lux Cellular fabrics may be ultrasonically cleaned.

Our light filtering and room darkening fabrics are inherently anti-static and repel dust, but occasional cleaning may be necessary to keep the fabrics clean and bright. The fabric can be dusted with a soft, clean cloth, feather duster or lightly vacuumed with a soft brush attachment. Spills and stains can be lightly blotted with a cloth or damp sponge. More difficult stains may require soaking in water with mild soap. For this, remove the shades from the window and soak in warm water. Complete immersion of hardware is not recommended.

DO NOT submerge the Cordless Ultra head rail in water. When damp, lay flat to dry or place back in window and raise tightly to recrisp pleats. Please test any stronger cleaners on an unobtrusive portion of the shade before using.

For additional advice on care or cleaning, please contact our Technical Services Department.

Scotchgard™ Treated Shades

The following are the recommended cleaning and care instructions for window treatments with fabric treated with Scotchgard™ Protector.

- Gently blot liquid stains immediately with a clean, white cloth.
- If stain remains, prepare a solution of ¼ teaspoon of clear, non-bleaching dish detergent mixed with 1 cup of lukewarm water. Dampen a clean white cloth and gently blot the stain.
- Do not over wet the fabric or excessively rub the stained area.
- See the Installation and Care instructions for complete details.

For additional assistance with stain removal, call the Scotchgard™ Protector Service Center at 1-800-433-3296. Customer Care representatives are available Monday through Friday, 8am to 6pm CT.

Measuring Instructions

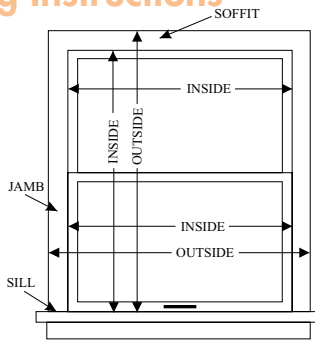

Comfortex accepts measurements down to $\frac{1}{16}$ " increments.

Inside Mount

Use a steel tape to measure the opening at three different places, and use the narrowest dimension when ordering. Be exact! The factory will make the shade $\frac{3}{8}$ " narrower so it will not rub against the window casing. Measure the height of the window from the top (soffit) down to the sill.

Outside or Ceiling Mount

Use a steel tape to measure the exact height and width of the area to be covered. It is recommended that the shades overlap the window by at least $1\frac{1}{2}$ " on each side. When installation has no sill, allow the shade to overlap the bottom of the window casing by at least $1\frac{1}{2}$ ". Shade fabric will measure width indicated on the order form.

Measuring for Specialty Shapes

Templates are required with some specialty shade orders. Consult the individual product sections of this guide for specifics regarding accurate measurements and mounting information.

Arches and Quarter Round Circles

- Measure the window height and width appropriately for an inside or outside mount.
- With perfect arches, the height will be one half the width. With perfect quarter rounds, height will equal width. If the arch or quarter round is perfect, **a template is not required.**
- Windows with imperfect arch measurements do not maintain the height/width relationship. Templates **are required** for these windows.

Trapezoids

- Measure the window height and width appropriately for an inside or outside mount. For outside mounts, remember to add the desired amount of overlap.
- Either the top or bottom of the shade is sloped or angled.
- Measure all four sides for accurate fabrication. Provide all measurements. **Templates are not required.**
- The slope angle must be measured with a protractor. Slope is the angle between slope and a horizontal line. The maximum slope is 30 degrees.

Octagons

- **Templates are required** and must be cut out of brown craft paper.
- Measure the window height and width appropriately for an inside or outside mount. Be sure to measure the width at the shade's widest point.
- Provide the width, length and the length of one side when ordering.

Making the Perfect Template

Tape brown craft paper over the window opening. Be sure to allow plenty of overlap and check to see that the paper is smooth and pulled taut. Do not use newspaper as the ink can rub off on fabric. Do not use paper that has been folded. Notice the outline of the framework superimposed on the template as the light filters through the window. You may create the template in one of two ways:

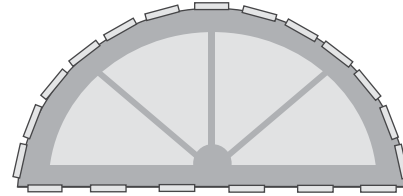

Trace the outline of the window with a pencil and continue along the side of the window frame. Once the window is completely traced, remove the craft paper from the window. Cut out the traced shape with a pair of scissors.

You may choose to skip tracing the window outline with a pencil and cut out the shape immediately with a razor knife.

Once your template is cut, double check its width and height with your initial measurements. Test the template by placing it in the window. Check for light gaps, uneven cutting of curves etc. Trim or remake if necessary.

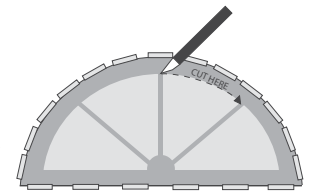

With arch top shades, fold the template in half. Check the outline of the curve for smoothness, light gaps and curve continuity. Place the template in the window and check it for light gaps or uneven cutting of curve. Trim or remake it if necessary.

On the front of the template, mark the shade measurements along with your company name, account number, sidemark, shade style and color. Be sure to indicate inside or outside mount, the room side and which ends of the template are top and bottom. Do not take any deductions on inside mount shades. The factory will make all necessary allowances for inside mounts.

Remember: The quality of the finished shades depends heavily on the quality of the template supplied. Do not hesitate to remake a template if you feel uncomfortable of the quality of your first attempt.

Template Kits: Comfortex offers template kits which includes brown craft paper, razor knife, instructions and order form. Please contact Customer Service or visit www.comfortex.com to order. Stock number: 751000

Color Lux® Shades

GENERAL INFORMATION

Conditions of Sale

All Comfortex products are custom fabricated to your exact specifications. We cannot accept responsibility for errors in ordering or cancellations and charges after the order is in production.

Policies

Our policies are designed to provide a guide for doing business with Comfortex. Our first priority and number one policy is to provide the highest level of service and total satisfaction.

Freight Policy

Fabricated Shades/Blinds

Comfortex will ship all orders for fabricated shades or blinds freight free via UPS, FedEx Ground or other similar method within the Continental US.

Transportation Surcharge: A \$6.00 per unit transportation surcharge will be added to all fabricated product orders shipping within the Continental US; including shades/blinds, vane packs, individual vanes, tracks, valance and cut yardage orders. Exception: Vertical Sheer Shadings, Ovation Cellular Slider and Envision Panel Track system will incur a \$15 per unit transportation surcharge up to 96”.

Oversized: In addition to the transportation surcharge, a \$45 per unit Common Carrier surcharge will be added to all fabricated products shipping within the Continental US, including shades/blinds, Vertical Sheer Shadings, Ovation Cellular Slider, Envision Panel Track system, valances, vane packs, individual vanes, tracks, and cut yardage orders with widths of over 96 inches.

Hawaii: Shipments to Hawaii will incur a freight charge of \$26.00 per unit when shipped from within the Continental US. In Addition, a \$132.00 per unit Common Carrier surcharge for oversized shades/blinds (over 96”) will be added to orders shipping to Hawaii.

Alaska: Shipments to Alaska will incur a \$26.00 per unit transportation surcharge when shipped from within the Continental US. In addition, a \$132.00 per unit Common Carrier surcharge for oversized shades/blinds (over 96”) will be added to orders shipping to Alaska from within the Continental US.

Canada: Shipments to Canadian Dealers will incur a \$7.75 per unit transportation surcharge when shipped from within the Continental US. In addition, a \$75.00 per unit Common Carrier surcharge for oversized shades/blinds (over 96”) will be added to orders shipping to Canada from within the Continental US.

Other Countries: All US Dealers requesting to ship orders outside the USA, must provide a Freight Forwarder for Comfortex to ship to within the Continental US. Comfortex cannot ship directly to your customers located outside USA.

Components and Fabric

Comfortex will prepay all freight charges on shipments of component and fabric orders over \$3,500 in value within the Continental US. Fabric and component orders less than \$3,500 will be subject to freight charges.

Shutter Components and Tools

Comfortex will prepay all freight charges on shipments of stock component and tool orders exceeding \$20,000 in value, within the Continental US only. All orders less than \$20,000 will be subject to all freight charges. Customers can elect a carrier of choice and receive a freight bill directly from the carrier or Comfortex will select a carrier and invoice the customer for the freight charges. Comfortex makes every effort to provide the most economical carrier and shipping method possible.

Charged Marketing Materials

All charged marketing materials will incur freight charges. Marketing materials may ship on separate days, from different locations. Freight charges are calculated per package, not per order.

Specifications

All Comfortex products are designed and tested to perform as intended within established, published parameters. Requests for “custom fabrication” of products outside of our published specifications may be considered, but are at the discretion of the Comfortex Technical Services department. Restrictions and additional charges apply.

Color Lux® Shades

GENERAL INFORMATION

Scotchgard™ Warranty

Comfortex Window Fashions provides a limited warranty for fabrics treated with Scotchgard™ Protector against permanent stains for a period of 1 year from the date of original purchase.

This warranty excludes conditions or damages resulting from accidents, alterations, exposure to the elements, and exposure to any and all natural and manufactured excessive heat sources, or failure to follow the Installation and Care instructions. This warranty also excludes fabric submerged in water or cleaning solutions, or treated with household products that may alter or deplete the effectiveness of the treated fabric. In addition, the following types of stains are excluded from this limited warranty: pet stains, bodily fluids, stains caused by wine, bleach, plant fertilizers, acne medication, misuse or abuse. This warranty is not a cleaning contract and does not cover the cleaning of fabrics that are soiled or discolored through daily use. This warranty coverage is limited to residential use and is not transferable.

The following are the recommended cleaning and care instructions for window treatments with fabric treated with Scotchgard™ Protector.

- Gently blot liquid stains immediately with a clean, white cloth.
- If stain remains, prepare a solution of ¼ teaspoon of clear, non-bleaching dish detergent mixed with 1 cup of lukewarm water. Dampen a clean white cloth and gently blot the stain.
- Do not over wet the fabric or excessively rub the stained area.
- See the Installation and Care instructions for complete details.

For additional assistance with stain removal, call the Scotchgard™ Protector Service Center at 1-800-433-3296. Customer Care representatives are available Monday through Friday, 8am to 6pm CT.

Should the results of the cleaning and care instructions not result in the removal of permanent stains covered by this limited warranty, Comfortex will retreat or replace the fabric, at it's discretion, for a period of 1 year from the date of original purchase. Customer must provide proof of purchase and provide proof the stain occurred during the warranty period. Shipping and handling costs to send the window treatment back to Comfortex are the responsibility of the customer.

This warranty gives you specific legal rights, and you may also have other rights which vary from state to state.

Sheer Horizontal Shadings Warranty Information

Knitted fabric may experience minor weave variations due to heat, humidity and other room conditions. These variations can result in light bowing, puckering and dimpling of the Shangri-La material. This is considered normal and does not constitute a failure in either workmanship or materials. The possible variations are minor and have been shown through case study not to detract from the beauty of the product.

Warranty Information Regarding the Braided Cord on Shangri-La Sheer Shadings with Designer Cassette Hardware:

Designer Cassette Shadings built with a braided cord do not have a reverse roll stop. If a Shangri-La Shading with the Designer Cassette Head Rail is raised above 24" in the reverse roll mode, there is a possibility of the fabric rubbing on the head rail. Comfortex reserves the right NOT to warrant wear and tear of fabric if damaged by roll-up in excess of 24".

Color Lux Cellular, Roller, Panel Track Shades and Sheer Horizontal Shadings Warranty Information

Comfortex warrants that its window treatments will be free from defects in materials and workmanship for as long as the original residential purchaser owns the product, provided that the product was installed properly and in accordance with the installation instructions. The Limited Lifetime Warranty is extended to the original residential purchaser only, in the original window for which it was installed.

The Warranty does not include any conditions or damages resulting from accidents, alterations, misuse, abuse, misapplication, improper handling, installation, repairs, operation, cleaning, exposure to any and all natural and manufactured excessive heat sources. (Excessive heat sources include, but not limited to; magnification of sun light through cubes of glass, heaters of any kind, ovens, candles, lighting fixtures, etc.) This warranty does not cover variation in fabric color, grain, or texture in natural wood products nor excessive warping of wood slats in high humidity areas. Loss of pleating is not covered if the product is not being cycled (held in the raised position a portion of the time). Normal wear and tear is not covered.

All moving parts, such as cords and strings (internal and external), will eventually wear out and fabric may fray. Comfortex considers these things as normal wear and tear and will carry a three year Limited Warranty. All fabric, including fabric vanes, panels, inserts, and shades carry a five year Warranty. Fabric cell separation is covered for a lifetime. See Comfortex Standard Return and Repair Policy for more details.

This Limited Warranty does not cover transportation costs to and from the retailer, costs of removal, re-measure, reinstallation of product, or any incidental or consequential damages.

If a Comfortex product is found to be defective in materials or workmanship, we will, at our discretion, repair, replace or refund the cost of a product which fails to conform to this Limited Warranty. Colors vary from lot to lot and may not exactly match sample swatch, sample book, or previous purchases. Discontinued components or color selections will be replaced with the closest equivalent current product. This shall be your sole remedy under this Limited Warranty.

To obtain service, contact the Dealer from whom you purchased the product.

This Warranty is exclusive and in lieu of all other obligations, liabilities or warranties. In no event shall Comfortex or its licensed fabricators or distributors be liable for incidental or consequential damages, or for any other damage, loss or expense, cost or fee associated with such damage. In some states, exclusions for incidental or consequential damages are not allowable. Comfortex Dealers and Fabricators must use safety devices supplied by Comfortex in accordance with Window Covering Safety Counsel guidelines.

This Warranty gives you specific legal rights, and you may also have other rights, which vary from state to state. Policy is subject to change without notice.

This Limited Warranty is exclusive of commercial use. Contact Comfortex Technical Service for more information. No agent, representative, dealer or unauthorized employee has the authority to increase or alter the obligation of this Warranty.

This Limited Warranty supersedes any previous versions.

Motorized Color Lux Shadings/Shades Warranty

Standard Simplicity and Simplicity Rechargeable Motors

We offer a 5 year warranty on all motors and controls. Specifically, we warrant the Simplicity motors and controls to be free from defects in material and workmanship under normal and proper use for a period of 5 years commencing with the date stamped on each product. If the Simplicity product fails within this 5 year period, we will repair or replace it free of charge through your end product supplier.

Color Lux Color Warranty

Comfortex utilizes state of the art technology to provide you Color Lux Shades within 2 Delta-E (DE) of the sample fabrics found in the Color Lux Sample Book. When viewed under different lighting sources such as fluorescent, incandescent, halogen, ultraviolet and others, fabrics may appear different to the eye. Comfortex utilizes the worldwide lighting standards of Daylight 65 (D65) as our official standard for measuring and qualifying color accuracy, because D65 daylight bulbs best represent actual "daylight" illumination. Slight color variations (under 2 DE) are within established industry standard and should be expected.

This warranty is in addition to Comfortex limited lifetime warranty.

©2020 COMFOTEX CORPORATION

™ is a trademark of Comfortex Corporation. ® is a registered trademark of Comfortex Corporation. Scotchgard, 3M and the Plaid Design are trademarks of 3M. The GREENGUARD INDOOR AIR QUALITY CERTIFIED Mark is a registered certification mark used under license through the GREENGUARD Environmental Institute. Energizer® is a registered trademark of Energizer Holdings, Inc. . Ovation™ Cellular Slider is covered by one or more of the following U.S. Patent Nos.: 4,862,941, 4,858,668, 4,915,153, D346,032, D324,108, 4,450,027, 4,631,108, 4,603,072, 5,690,778, 5,664,773, 6,319,586, 5,482,750, 5,601,885 and 4,631,217. Karma-Light™, Cordless Ultra™, Sunset™, and Ovation™ are trademarks of Comfortex Corporation. Other U.S. and foreign patents pending.



Midwest
Designer
Supply

1-888-523-2611

**Midwest Designer Supply, Inc.
N30W22377 Green Road Ste C
Waukesha, WI 53186
(262) 523-2600
Fax (262) 524-1007
www.midwestdesignersupply.com**

MDS - your one source for window fashions.